

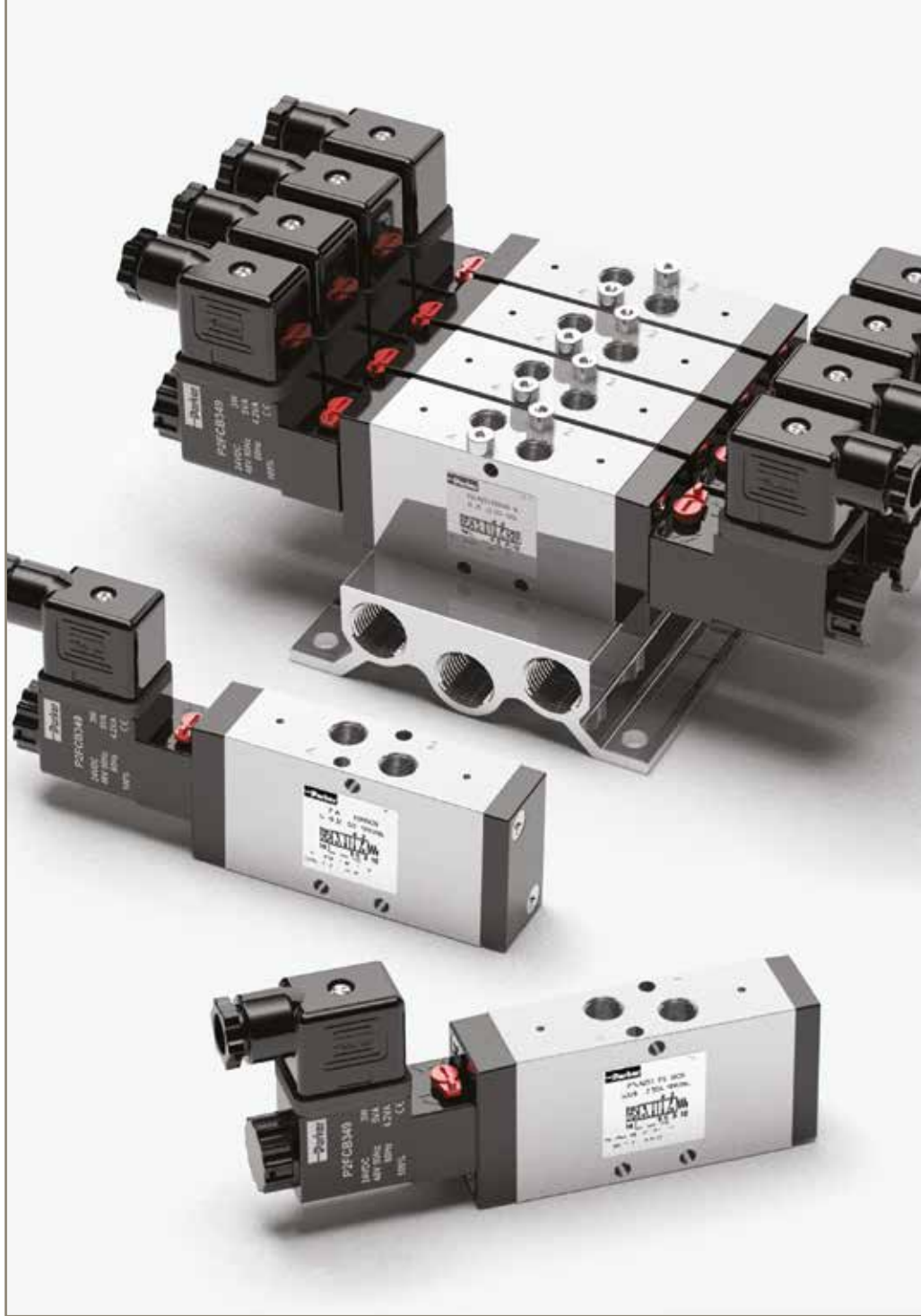

aerospace
climate control
electromechanical
filtration
fluid & gas handling
hydraulics
pneumatics
process control
sealing & shielding



Pneumatic Valves Viking Lite Series

G1/8 - G3/8 body ported

Catalogue PDE2658TCUK May 2015



ENGINEERING YOUR SUCCESS.

Material Specification.....	3 - 6
Flow Characteristics.....	7
Viking Lite Part Number System.....	8
Main Data Electrically Actuated Directional Control Valves.....	9
Dimensions - P2LAZ / P2LBZ / P2LCZ.....	10 - 15
P2LA, Accessory Order Codes	17
P2LB, Accessory Order Codes	16 - 18
Manifold Dimensions.....	16 - 18
Solenoid Valves - 22mm.....	19
Solenoid Valves Technical Data - 22mm.....	20
Solenoid Connectors + Cable Plugs.....	20



Important !
 Before carrying out any service work, ensure that the valve and manifold have been vented. Remove the primary supply air hose to ensure total disconnection of the air supply before dismantling valves or blank connection blocks.



NB !
 All technical data in this catalogue is typical only. The air quality is decisive for the valve life: see ISO 8573.



WARNING

FAILURE OR IMPROPER SELECTION OR IMPROPER USE OF THE PRODUCTS AND/OR SYSTEMS DESCRIBED HEREIN OR RELATED ITEMS CAN CAUSE DEATH, PERSONAL INJURY AND PROPERTY DAMAGE.
 This document and other information from Parker Hannifin Corporation, its subsidiaries and authorized distributors provide product and/or system options for further investigation by users having technical expertise. It is important that you analyze all aspects of your application and review the information concerning the product or system in the current product catalog. Due to the variety of operating conditions and applications for these products or systems, the user, through its own analysis and testing, is solely responsible for making the final selection of the products and systems and assuring that all performance, safety and warning requirements of the application are met. The products described herein, including without limitation, product features, specifications, designs, availability and pricing, are subject to change by Parker Hannifin Corporation and its subsidiaries at any time without notice.

SALE CONDITIONS

The items described in this document are available for sale by Parker Hannifin Corporation, its subsidiaries or its authorized distributors. Any sale contract entered into by Parker will be governed by the provisions stated in Parker's standard terms and conditions of sale (copy available upon request).

Viking Lite ...

robust, versatile high performance
with long service life

The Viking Lite valve range is robust, versatile and combines high performance with compact installation dimensions. The choice of G1/8, G1/4 or G3/8 port sizes provide large flow capacity, short change-over times for maximum productivity and the low change-over pressure is an important characteristic of this valve range.

Designed to operate with pressures up to 10 bar in temperatures -10°C to + 50°C.

Wear compensating system

Viking Lite valves are fitted with dynamic bi-directional spool seals suitable for pressures up to 10 bar, in ambient temperatures -10°C to + 50°C. Under pressure radial expansion of the seal occurs to maintain sealing contact with the valve bore.

This sealing method reduces friction gives lower pilot pressures, providing fast response and less wear. Valves do not require lubrication in operation but they can also be installed in systems that are lubricated.

Viking Lite range

P2LAZ, G1/8 - Cv = 0.6

P2LBZ, G1/4 - Cv = 1.5

P2LCZ, G3/8 - Cv = 2.5

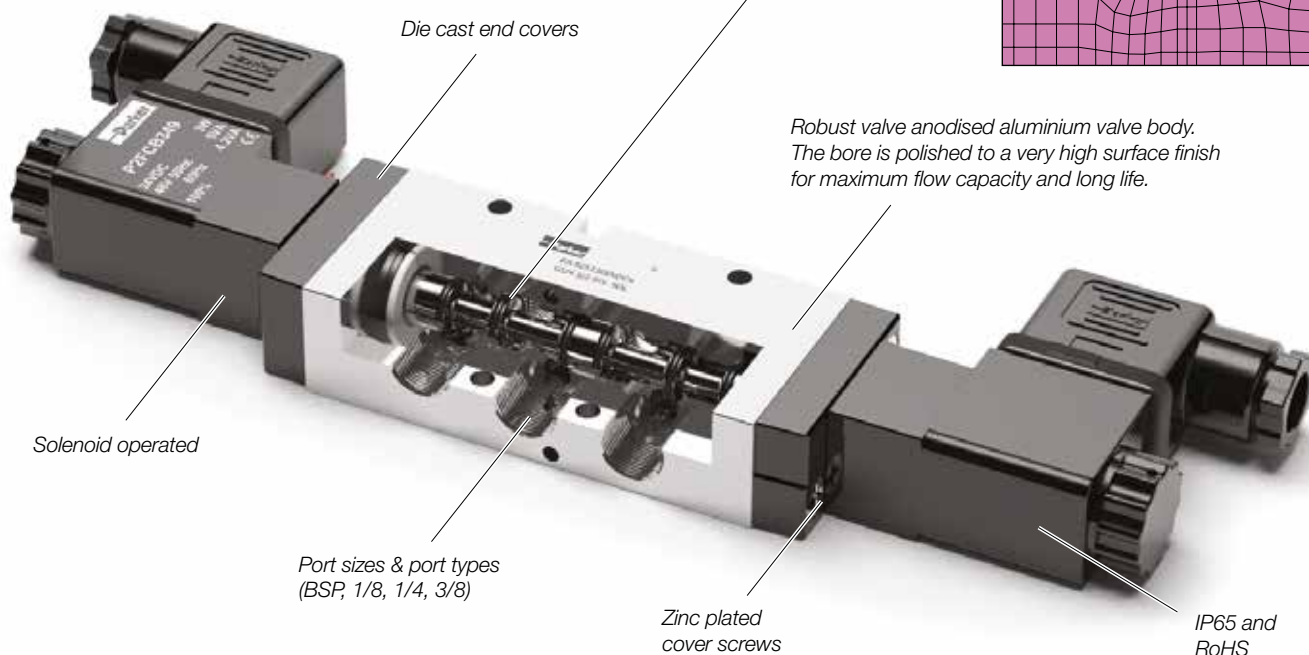

Viking Lite ...

rust and corrosion resistant,
high reliability with flexible installation



Rust and corrosion resistant designs.

Viking Lite valves are made of anodized aluminium, for good corrosion resistance. The smooth design, with no dirt-collecting pockets, makes the valve suitable for most environments.

High reliability

Viking Lite valves easily comply with the requirements for the component reliability in accordance with EU Machinery Directive standards EN292-2 and EN983. The valves are designed for use with or without supplementary lubrication.

Compact dimensions for flexibility in installations

Compact dimensions, direct body porting and integral mounting holes are all features of the Viking Lite range.

In addition to single valve installation, the Viking Lite valves may be installed on manifolds so that the valves have a common supply and manifolded exhausts.

Manifold bar installation

A manifold bar, with common ducts for ports 1, 3 and 5 gives simple, time saving and easily serviced installation. Manifold bars are available in several different sizes, with space for between 2 and 14 valves.

Pressure bar installation

A pressure bar for common primary air supply gives a simple, robust, time saving and easily serviced installation. When pressure bars are used, restrictor-silencers can be installed in the exhaust ports of each valve, for individual adjustment of cylinder/air motor speed. Pressure bars are available in a number of different sizes, with space ranging from 2 to 10 valves.

Extreme applications

For extreme applications, -40 degrees and up to 16 bar pressure use

VikingXtreme valves :
see catalogue PDE2569TCUK

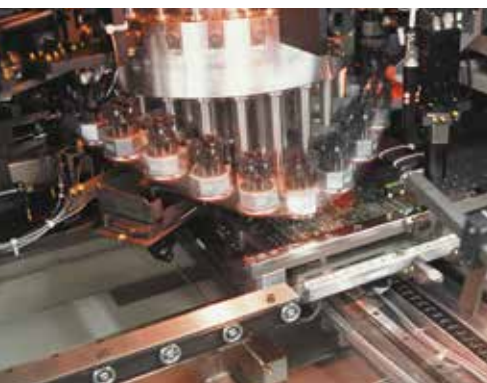

Working medium, air quality

Working medium: Dry, filtered compressed air to ISO 8573-1 class 3.4.3.

Recommended air quality for valves

For best possible service life and trouble free operation, ISO 8573-1 quality class 3.4.3 should be used. This means 5µm filter (standard filter) dew point +3°C for indoor operation (a lower dew point should be selected for outdoor operation) and oil concentration 1.0 mg oil/m³, which is what a standard compressor with a standard filter gives.

ISO 8573-1 quality classes

Quality class	Pollution		Water max. press. dew point (°C)	Oil max. concentration (mg/m ³)
	particle size (µm)	max. concentration (mg/m ³)		
1	0,1	0,1	-70	0,01
2	1	1	-40	0,1
3	5	5	-20	1,0
4	15	8	+3	5,0
5	40	10	+7	25
6	-	-	+10	-

Typical cylinder speeds which can be achieved with Viking valves and different tube sizes.

In the chart below you can find the suitable valves, tubes etc. for each cylinder size. If you have a tube length over 2m, choose one tube size larger than in the chart.

Following data is valid:

- Supply pressure : min 7.0 bar
- Regulator pressure setting : 6.0 bar
- Pipe length between air treatment unit and valve : max 1m
- Pipe length between valve and cylinder : max 2m

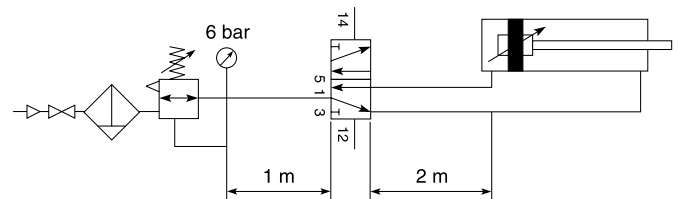

Cylinder bore	<20	20-32	40-50	63	80	100	125
Cylinder port	M5	G1/8	G1/4	G3/8	G3/8	G1/2	G1/2
Tubing Ext/Int	4/2.7	6/4	8/6	10/8	10/8	12/9	14/11
			6/4	8/6	12/9	14/11	
P2LAZ	G1/8	G1/8	G1/8	G1/8	G1/8		
P2LBZ	G1/4	G1/4	G1/4	G1/4	G1/4	G1/4	
P2LCZ			G3/8	G3/8	G3/8	G3/8	G3/8

- Cylinder speed < 0,5 m/s
- Cylinder speed < 1 m/s
- Oversized
- Cylinder speed > 1 m/s

Material specification

P2LAZ

Valve

Valve body	Anodised aluminium
End covers	Anodised aluminium
Spool	Aluminium
Piston	Acetal plastic/ Anodised aluminium
End cover sealings	Nitrile rubber
End cover screws	Zinc plated steel
Springs	Stainless steel
Mounting screws for solenoid	Stainless steel
Spool seals	Nitrile
Pilot adaptor	Acetal plastic

Accessories

Manifold bar	Anodised aluminium
Pressure bar	Anodised aluminium

P2LCZ

Valve

Valve body	Anodised aluminium
End covers	Anodised aluminium
Spool	Aluminium
Piston	Acetal plastic/ Anodised aluminium
End cover sealings	Nitrile rubber
End cover screws	Zinc plated steel
Springs	Stainless steel
Mounting screws for solenoid	Stainless steel
Spool seals	Nitrile
Pilot adaptor	Acetal plastic

P2LBZ

Valve

Valve body	Anodised aluminium
End covers	Anodised aluminium
Spool	Aluminium
Piston	Acetal plastic/ Anodised aluminium
End cover sealings	Nitrile rubber
End cover screws	Zinc plated steel
Springs	Stainless steel
Mounting screws for solenoid	Stainless steel
Spool seals	Nitrile
Pilot adaptor	Acetal plastic

Accessories

Manifold bar	Anodised aluminium
Pressure bar	Anodised aluminium

Flow characteristics

Flow capacities in accordance with ISO6358

All pressures = effective pressure

The curves in the diagram below are typical only

Technical Data P2LAZ

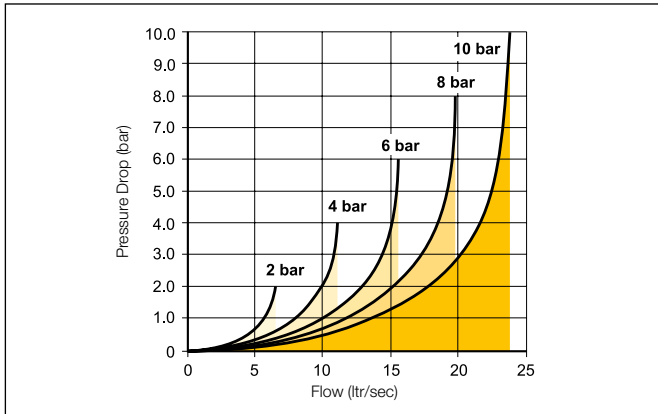

Port size	G1/8
Maximum Operating pressure	10 bar
Working temperature.	-10°C to + 50°C
Flow (acc. to ISO 6358)	c = 2.2 NI/s x bar b = 0.3 Qn = 10.1 l/s Qmax = 15.6 l/s Cv = 0.6

Technical Data P2LBZ

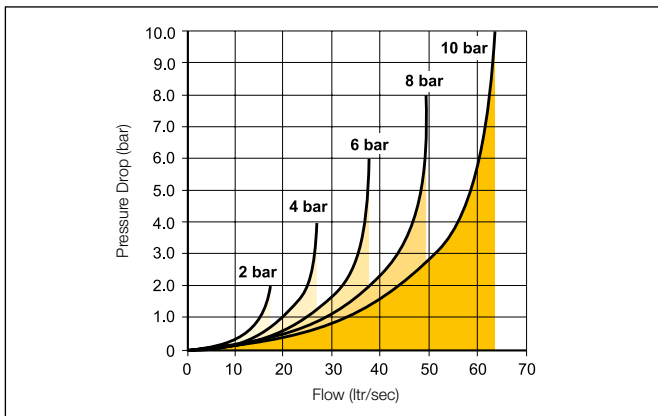

Port size	G1/4
Maximum Operating pressure	10 bar
Working temperature.	-10°C to + 50°C
Flow (acc. to ISO 6358)	c = 5.4 NI/s x bar b = 0.3 Qn = 24.6 l/s Qmax = 37.8 l/s Cv = 1.5

Technical Data P2LCZ

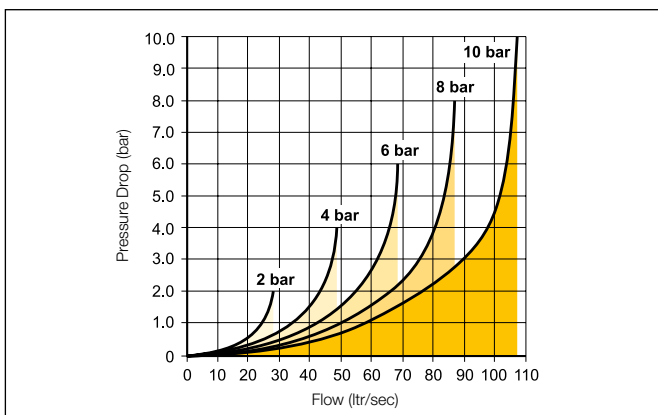

Port size	G3/8
Maximum Operating pressure	10 bar
Working temperature.	-10°C to + 50°C
Flow (acc. to ISO 6358)	c = 9.7 NI/s x bar b = 0.3 Qn = 41.5 l/s Qmax = 68.3 l/s Cv = 2.5

Viking Lite Part Number System

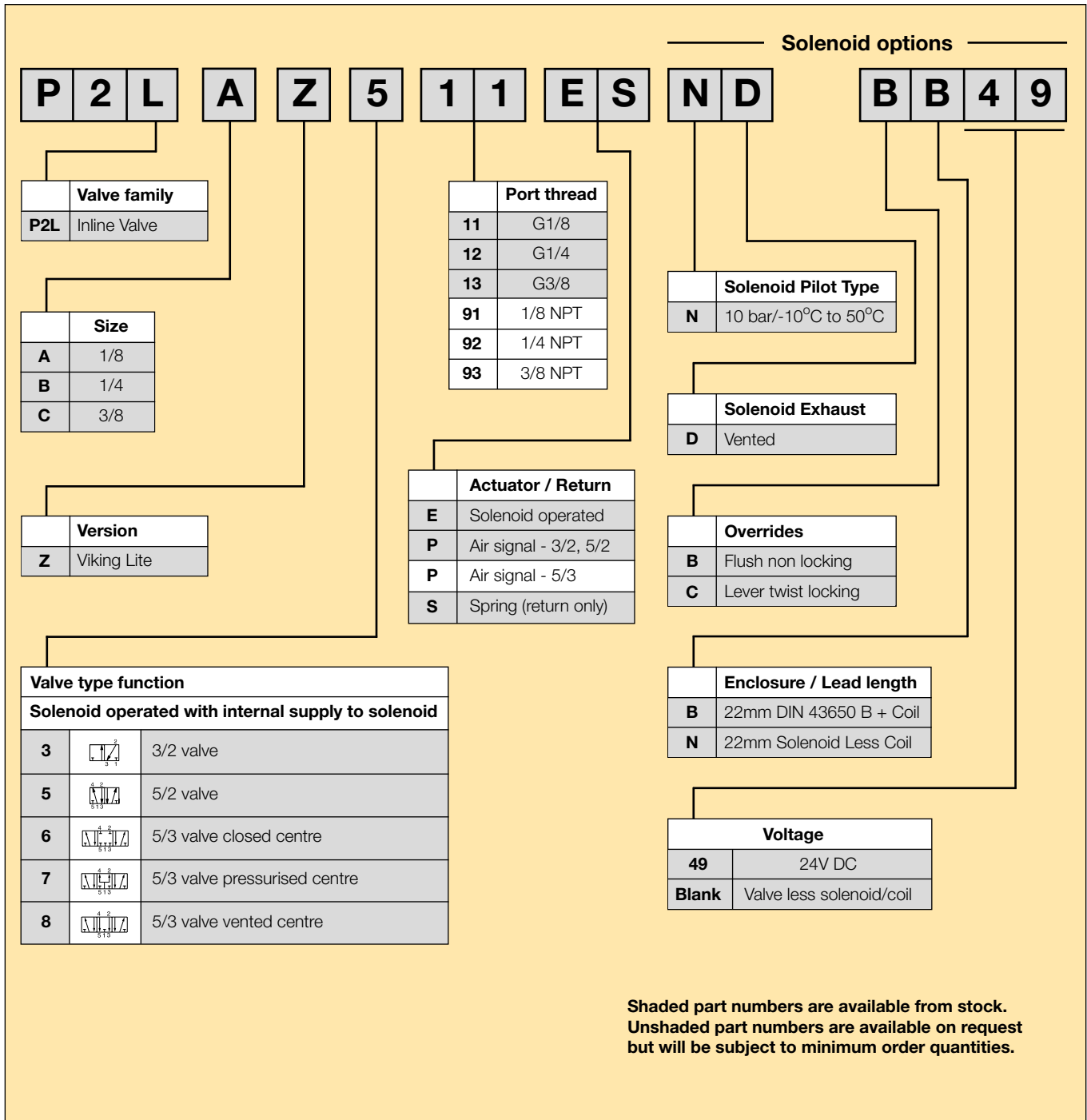

Solenoid operated directional control valves

Internal supply to solenoid valve(s) via port 1.

Max operating pressure 10 bar, temperature range -10°C to +50°C

3/2 valves, internal air, standard temperature

Symbol	Size	Actuation	Return	Min Operating Pressure (bar)	Changeover time (ms) at 6 bar @20°C actua./return	Weight Kg	Order code Without coil	Order code With 24V DC (22mm coil)
	G1/8	Air signal	Air signal	1.5	5/5	0.18	P2LAZ311PP	
	G1/4			1.5	6/6	0.18	P2LBZ312PP	
	G3/8			1.5	8/8	0.36	P2LCZ313PP	
	G1/8	Air signal	Spring	3.0	8/15	0.16	P2LAZ311PS	
	G1/4			3.0	10/20	0.16	P2LBZ312PS	
	G3/8			3.0	10/30	0.35	P2LCZ313PS	
	G1/8	Electric signal	Electric signal	1.5	10/10	0.18	P2LAZ311EENDCN	P2LAZ311EENDCB49
	G1/4			1.5	12/12	0.18	P2LBZ312EENDCN	P2LBZ312EENDCB49
	G3/8			1.5	17/17	0.36	P2LCZ313EENDCN	P2LCZ313EENDCB49
	G1/8	Electric signal	Spring	3.0	15/35	0.16	P2LAZ311ESNDCN	P2LAZ311ESNDCB49
	G1/4			3.0	18/45	0.16	P2LBZ312ESNDCN	P2LBZ312ESNDCB49
	G3/8			3.0	27/75	0.35	P2LCZ313ESNDCN	P2LCZ313ESNDCB49

5/2 valves, internal air, standard temperature

Symbol	Size	Actuation	Return	Min Operating Pressure (bar)	Changeover time (ms) at 6 bar @20°C actua./return	Weight Kg	Order code Without coil	Order code With 24V DC (22mm coil)
	G1/8	Air signal	Air signal	1.5	5/5	0.18	P2LAZ511PP	
	G1/4			1.5	6/6	0.18	P2LBZ512PP	
	G3/8			1.5	8/8	0.36	P2LCZ513PP	
	G1/8	Air signal	Spring	3.0	8/15	0.16	P2LAZ511PS	
	G1/4			3.0	10/20	0.16	P2LBZ512PS	
	G3/8			3.0	10/30	0.35	P2LCZ513PS	
	G1/8	Electric signal	Electric signal	1.5	10/10	0.19	P2LAZ511EENDCN	P2LAZ511EENDCB49
	G1/4			1.5	12/12	0.21	P2LBZ512EENDCN	P2LBZ512EENDCB49
	G3/8			1.5	17/17	0.44	P2LCZ513EENDCN	P2LCZ513EENDCB49
	G1/8	Electric signal	Spring	3.0	15/35	0.17	P2LAZ511ESNDCN	P2LAZ511ESNDCB49
	G1/4			3.0	18/45	0.20	P2LBZ512ESNDCN	P2LBZ512ESNDCB49
	G3/8			3.0	27/75	0.43	P2LCZ513ESNDCN	P2LCZ513ESNDCB49

5/3 valves, internal air, standard temperature

Symbol	Size	Actuation	Return	Min Operating Pressure (bar)	Changeover time (ms) at 6 bar @20°C actua./return	Weight Kg	Order code Without coil	Order code With 24V DC (22mm coil)
	G1/8	Electric/Electric	Self centring	3.0	18/40	0.26	P2LAZ611EENDCN	P2LAZ611EENDCB49
	G1/4		Closed	3.0	22/55	0.28	P2LBZ612EENDCN	P2LBZ612EENDCB49
	G3/8		Centre	3.0	30/90	0.60	P2LCZ613EENDCN	P2LCZ613EENDCB49
	G1/8	Electric/Electric	Self centring	3.0	18/40	0.26	P2LAZ711EENDCN	P2LAZ711EENDCB49
	G1/4		Presurised	3.0	22/45	0.28	P2LBZ712EENDCN	P2LBZ712EENDCB49
	G3/8		Centre	3.0	30/90	0.60	P2LCZ713EENDCN	P2LCZ713EENDCB49
	G1/8	Electric/Electric	Self centring	3.0	18/40	0.26	P2LAZ811EENDCN	P2LAZ811EENDCB49
	G1/4		Vented	3.0	22/45	0.28	P2LBZ812EENDCN	P2LBZ812EENDCB49
	G3/8		Centre	3.0	30/90	0.60	P2LCZ813EENDCN	P2LCZ813EENDCB49

Dimensions

P2LAZ 3/2
 Air / Air

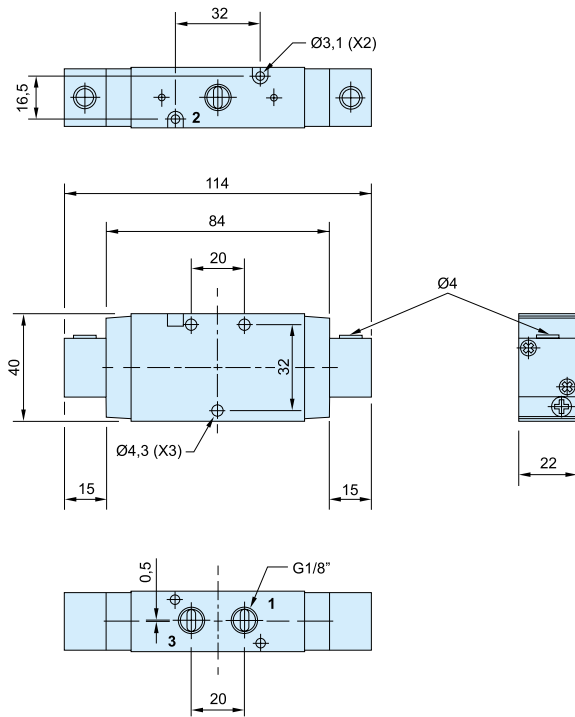

P2LAZ 3/2
 Air / Spring

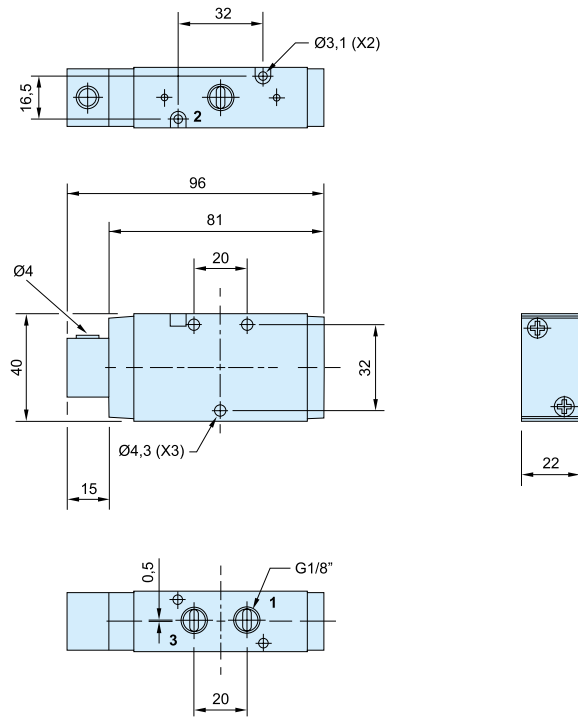

P2LAZ 3/2
 Solenoid / Solenoid

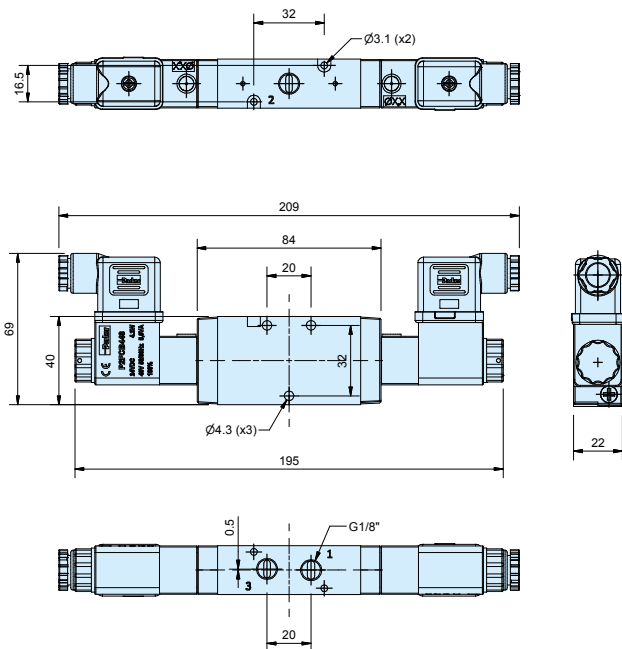

P2LAZ 3/2
 Solenoid / Spring

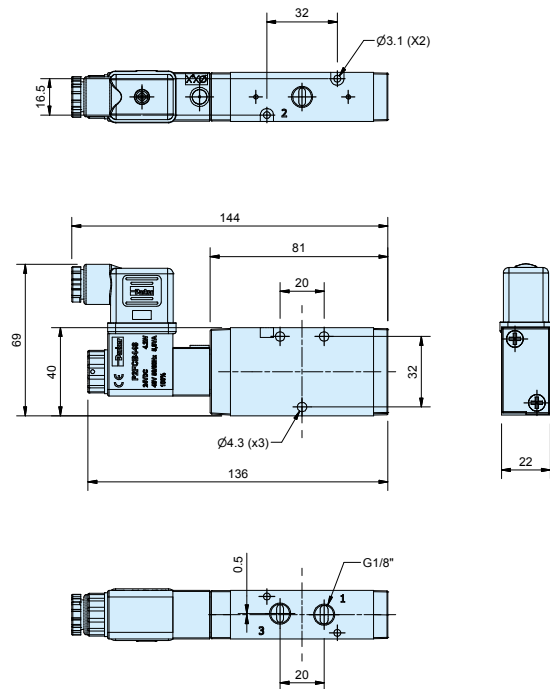

Solenoid valves

Solenoid valves and cable plugs must be ordered separately. One pilot valve is required for each E (NDCN only) in the valve order code.

Dimensions

P2LAZ 5/2
Solenoid / Solenoid

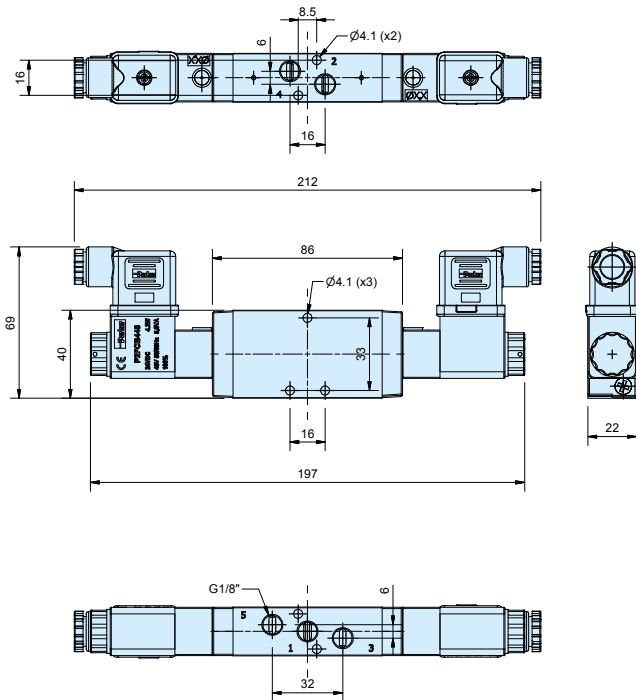

P2LAZ 5/2
Solenoid / Spring

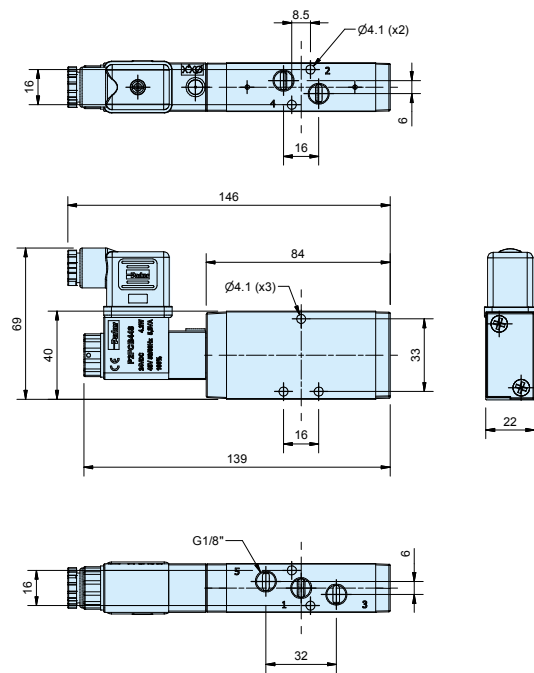

P2LAZ 5/3
Solenoid / Solenoid

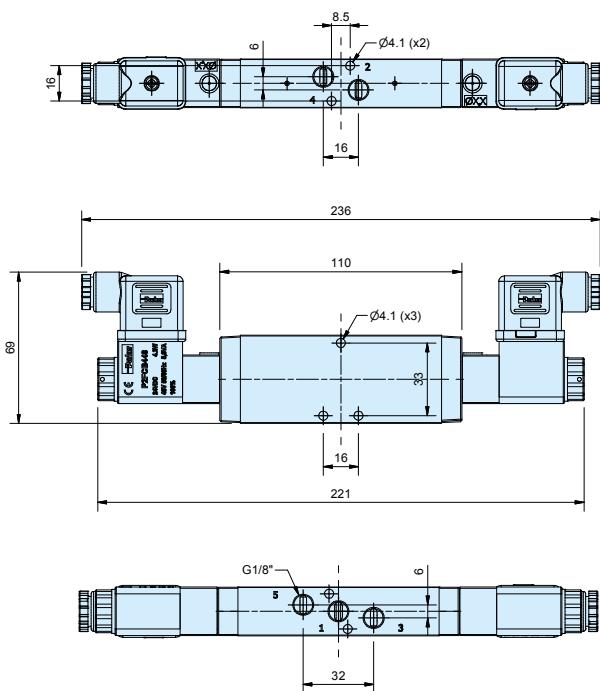

Solenoid valves
 Solenoid valves and cable plugs must be ordered separately.
 One pilot valve is required for each E (NDCN only) in the valve order code.

Dimensions

P2LBZ 3/2
 Air / Air

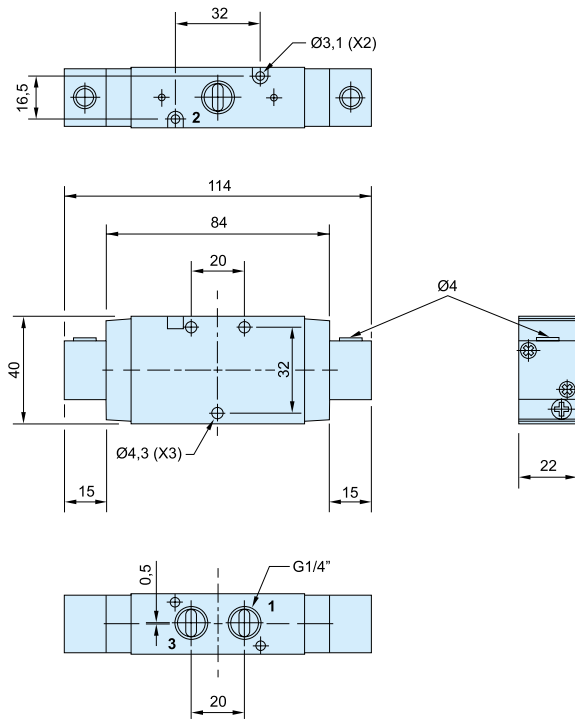

P2LBZ 3/2
 Air / Spring

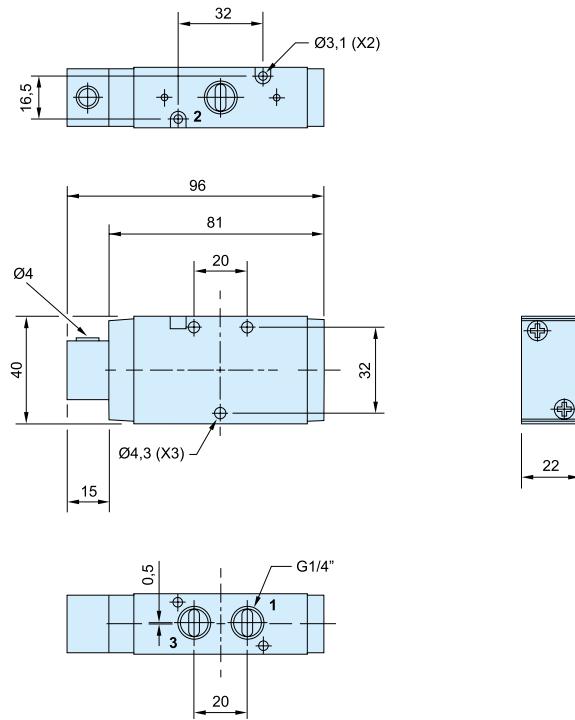

P2LBZ 3/2
 Solenoid / Solenoid

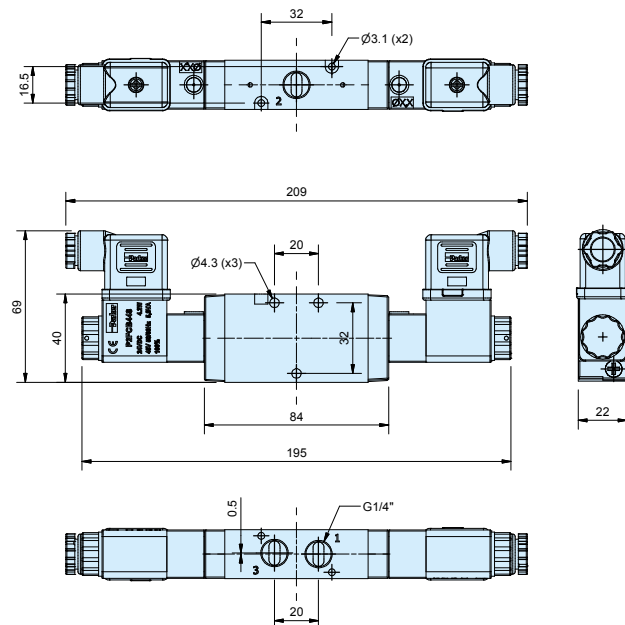

P2LBZ 3/2
 Solenoid / Spring

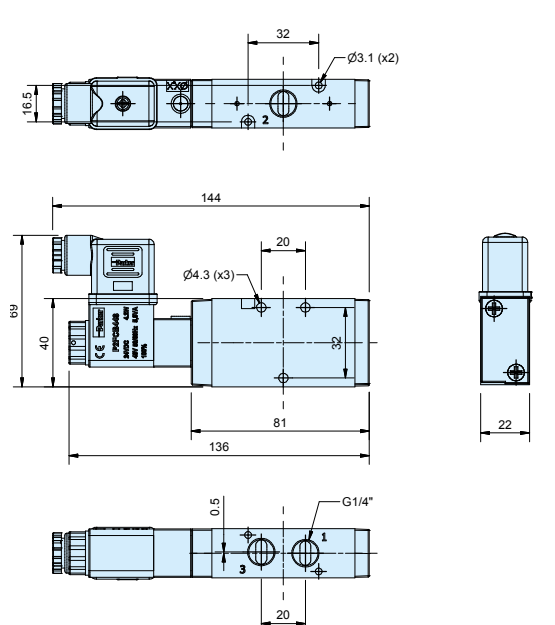

Solenoid valves

Solenoid valves and cable plugs must be ordered separately.
 One pilot valve is required for each E (NDCN only) in the valve order code.

Dimensions

P2LBZ 5/2
Solenoid / Solenoid

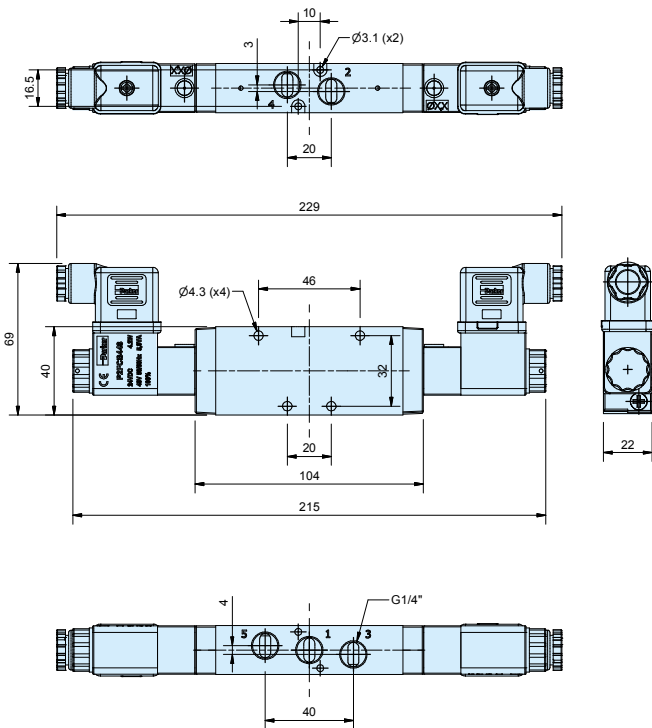

P2LBZ 5/2
Solenoid / Spring

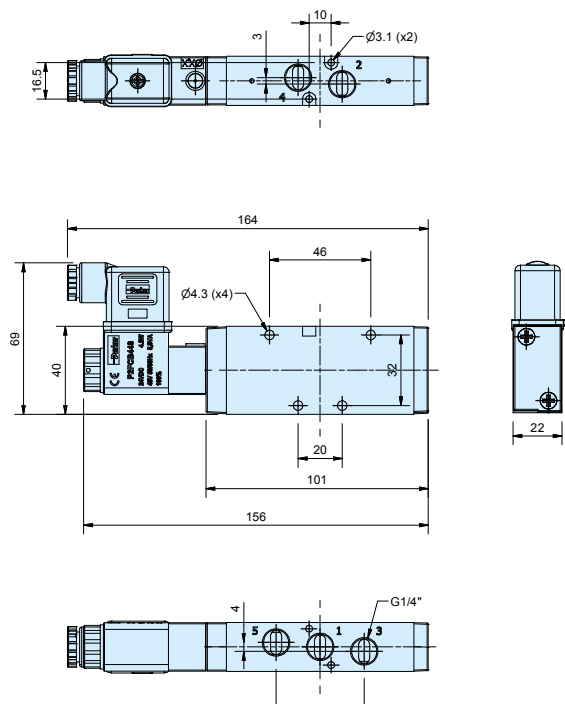

P2LBZ 5/3
Solenoid / Solenoid

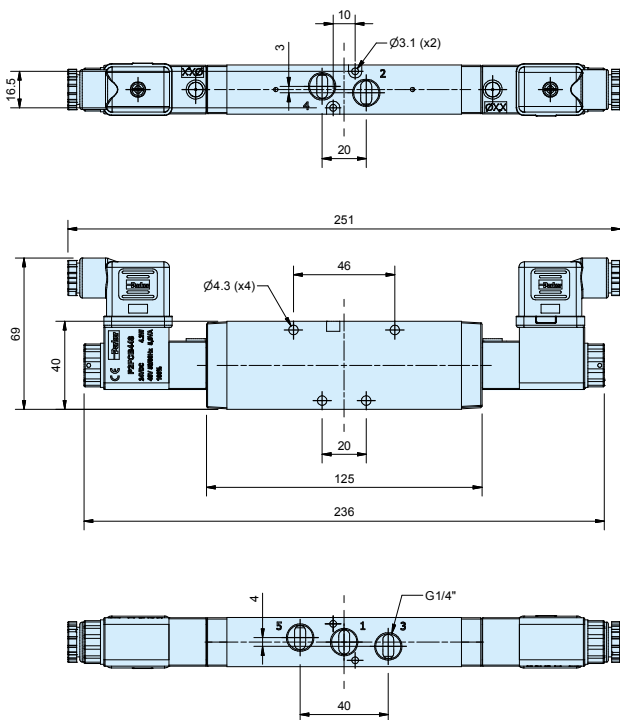

Solenoid valves
Solenoid valves and cable plugs must be ordered separately.
One pilot valve is required for each E (NDCN only) in the valve order code.

Dimensions

P2LCZ 3/2
Air / Air

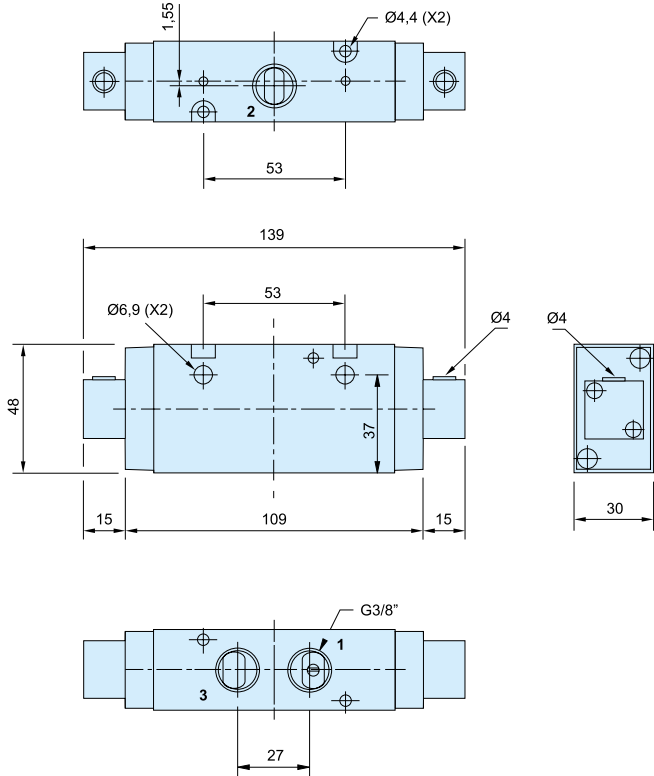

P2LCZ 3/2
Air / Spring

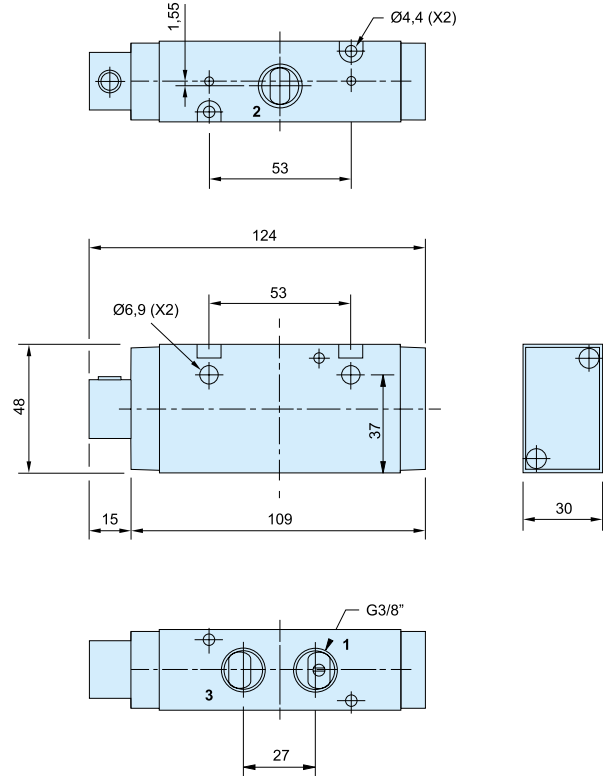

P2LCZ 3/2
Solenoid / Solenoid

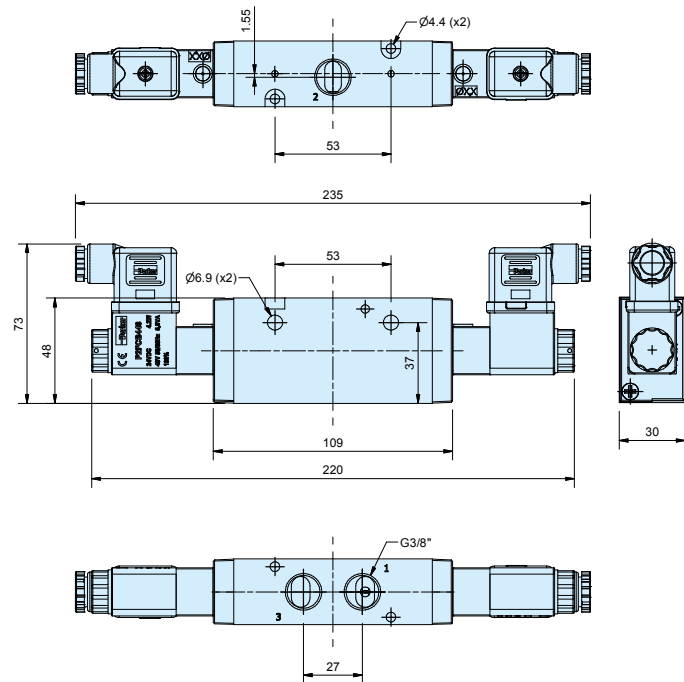

P2LCZ 3/2
Solenoid / Spring

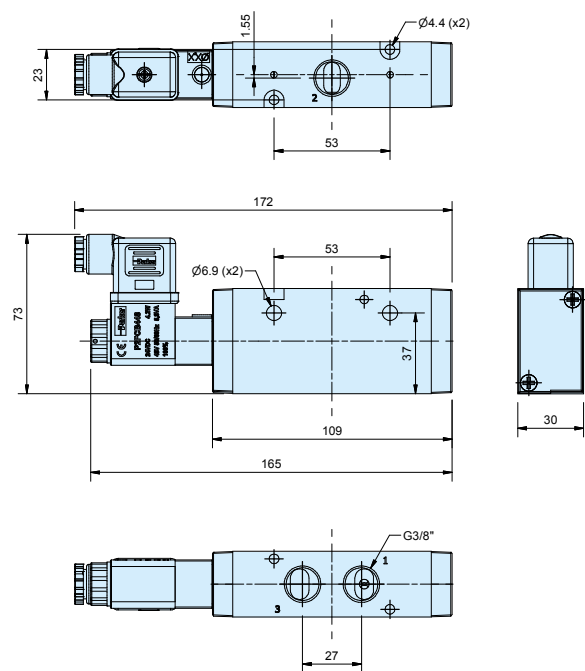

Dimensions

P2LCZ 5/2

Solenoid / Solenoid

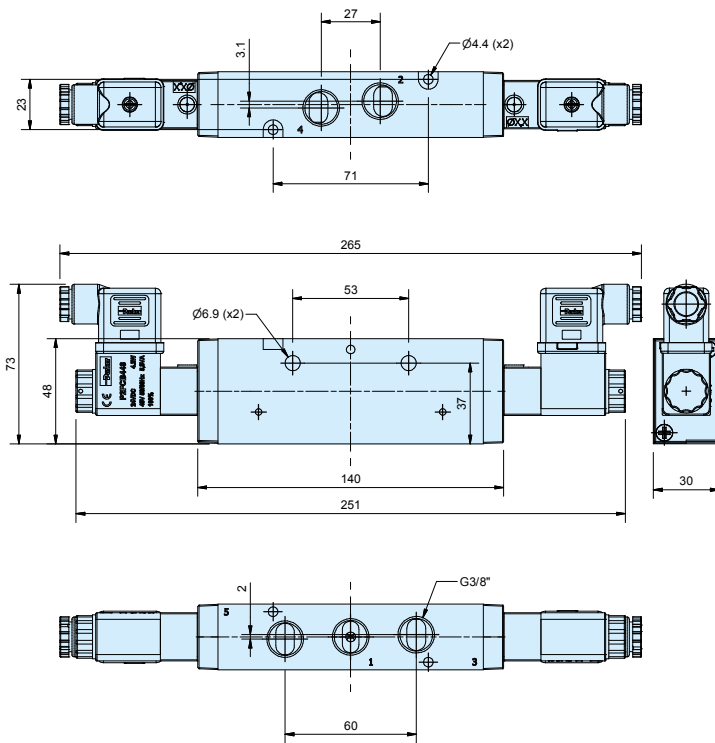

P2LCZ 5/2

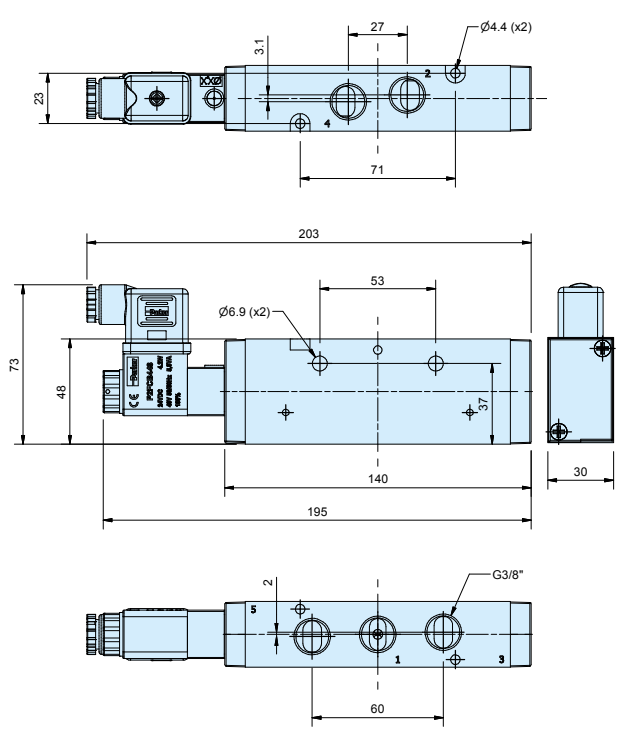

Solenoid / Spring

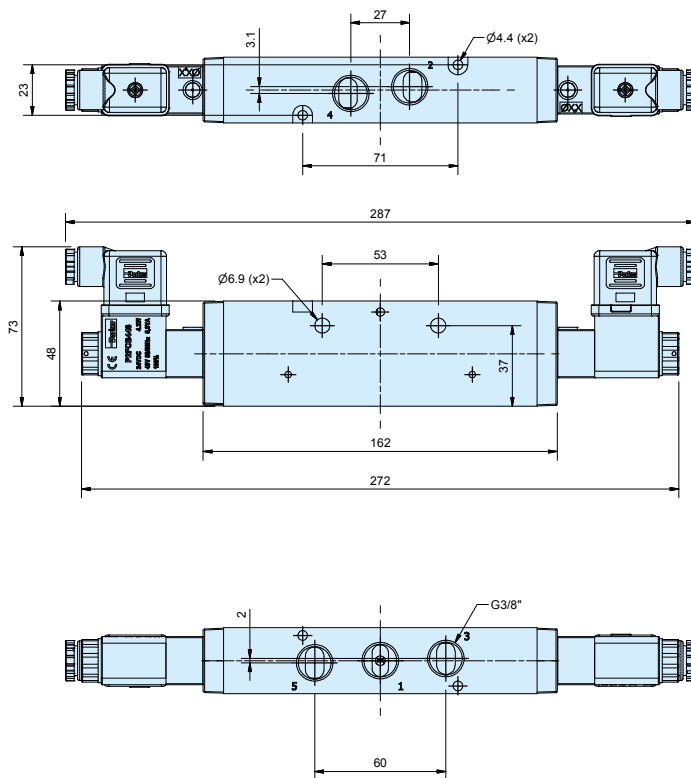

P2LCZ 5/3

Solenoid / Solenoid



Accessories	Type P2LA / P2LB 3/2 valves	Weight kg	Order code	
	Manifold bar, P2LB incl. fasteners and O-ring. G3/8 For 2 valves For 4 valves For 6 valves For 8 valves For 10 valves	0.38 0.64 0.89 1.15 1.40	91213202SXZ 91213204SXZ 91213206SXZ 91213208SXZ 91213210SXZ	
		Blanking plate for Manifold bar	0.10	912132BPSXZ

Dimensions



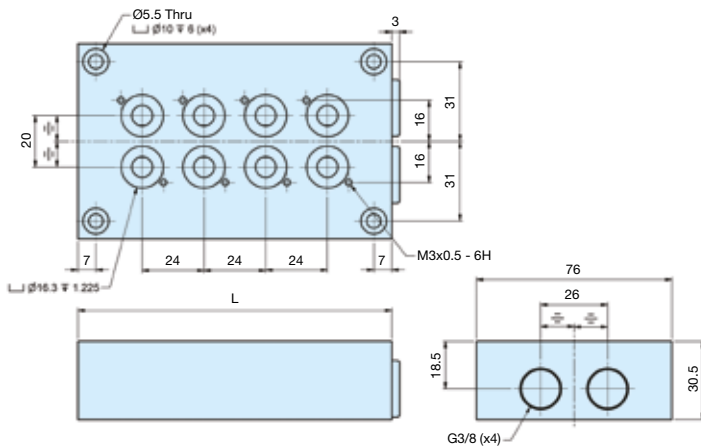



Manifold bar

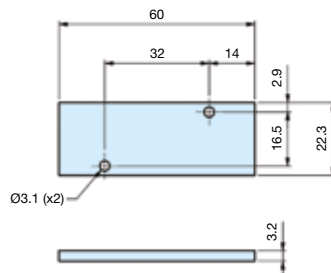

No. of valves	L mm
2	74
4	122
6	170
8	218
10	266

Blanking plate for manifold bar, P2LB



Accessories	Type P2LA 5/2 valves	Weight kg	Order code
	Manifold bar, P2LA including seals, mounting screws. G3/8 For 4 valves For 6 valves For 8 valves For 10 valves For 12 valves For 14 valves	0.48 0.63 0.80 0.98 1.10 1.23	9121658075 9121658076 9121658077 9121658078 9121658079 9121658099
	Blanking plate, P2LA for Manifold bar	0.05	9121658063
	Pressure bar, P2LA for common air supply incl. O-rings and mounting screws. G1/4 For 2 valves For 4 valves For 6 valves For 8 valves	0.13 0.20 0.26 0.33	9121658070 9121658071 9121658072 9121658073
	Blanking plate, P2LA for Pressure bar	0.05	9121658074
	Assembly screws, P2LA in stainless steel for valve	0.02	9121658043
	Assembly screws, P2LA in stainless steel for blanking plate	0.01	9121658044
	O-ring kit, P2LA O-rings between valve and manifold bar/Pressure bar	0.01	9121658046

Dimensions

Manifold bar, P2LA

No. of valves	L mm
4	126
6	174
8	222
10	270
12	318
14	366

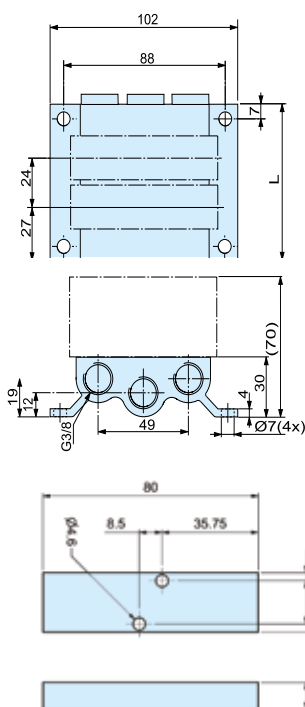

Blanking plate for manifold bar, P2LA



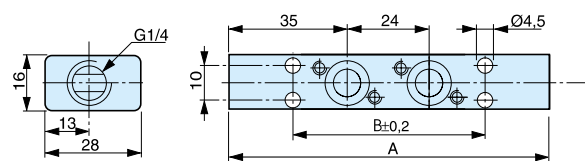

Pressure bar, P2LA

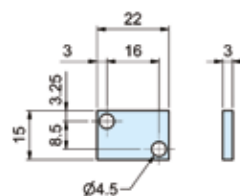

Blanking plate for pressure bar, P2LA



No. of valves	A mm	B mm
2	94	56
4	142	104
6	190	152
8	238	200

Accessories	Type P2LB 5/2 valves	Weight kg	Order code
	Manifold bar, P2LB incl. fasteners and O-ring. G3/8 For 2 valves For 4 valves For 6 valves For 8 valves For 10 valves	0.69 1.13 1.56 2.00 2.45	9121594805X 9121594806X 9121594807X 9121594808X 9121594812X
	Blanking plate, P2LB for Manifold bar	0.10	9121594809X
	Pressure bar, P2LB for common air supply incl. O-rings and mounting screws. G3/8 For 2 valves For 4 valves For 6 valves For 8 valves For 10 valves	0.38 0.53 0.68 0.83 0.99	9127113301X 9127113302X 9127113303X 9127113304X 9127113305X
	Blanking plate P2LB for Pressure bar. G1/4	0.02	9127113306X

Dimensions

Manifold bar, P2LB

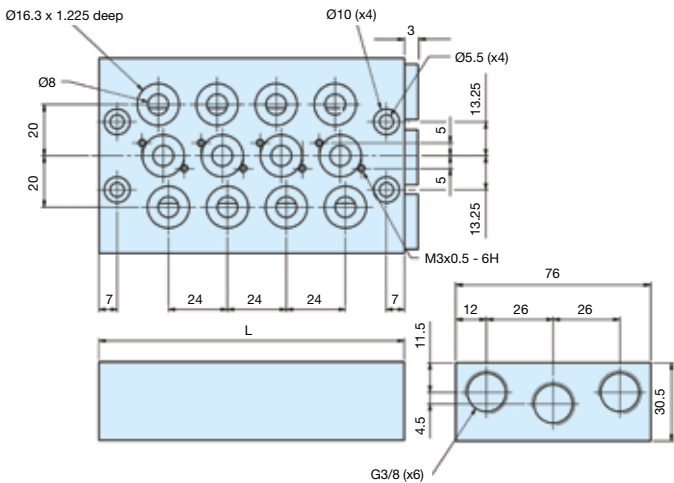

No. of valves	L mm
2	74
4	122
6	170
8	218
10	266

Blanking plate for manifold bar, P2LB

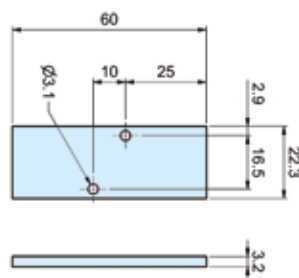

Pressure bar, P2LB

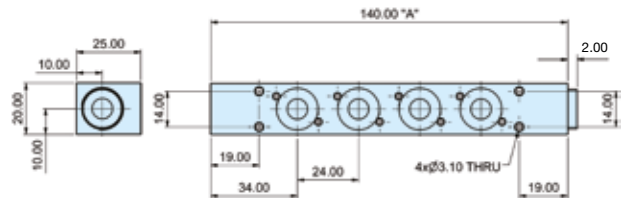

Blanking plate for pressure bar, P2LB

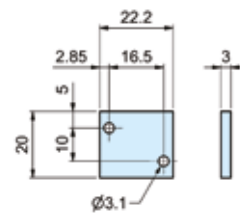

No. of valves	A mm
2	92
4	140
6	188
8	236
10	284



22mm Solenoid pilot options

The solenoid pilot operators are designed for piloting pneumatic control valves with compressed air or other inert gases.

The operator is available for normal operating pressures up to 10 bar having an outlet orifice 1.2 mm and exhaust orifice 1.45 mm.

Corrosion resistant design

The pilot operator body is manufactured in thermoplastic PA 6 material and the core tube brass is stainless steel. The plunger/core is also made from stainless steel and the valve seats from FKM.

Solenoid Pilot Exhaust

These operators all exhaust out of the top of the core tube which is tapped M5. The standard solenoid nut fitted to the core tube is the Diffuser nut which allows the exhaust to escape to atmosphere. This nut also minimises ingress of dirt into the valve through this port. The alternative plastic knurled nut can be specified (refer to part number system) if the exhaust air needs to be captured and piped away using the M5 tapped port.

Coils

Coils are wound with enameled copper wire, having temperature index 180°C with class F insulation (155°C) and are encapsulated in Thermoplastic resin.

When fitted with suitable connector and correct gasket they give protection to IP65.

Manual Override options

The standard manual override is the bi-stable twist lock, extended plastic override. Non locking flush manual override available as option.

22mm solenoid operator part numbers and spares

Solenoid coils for 22mm solenoid operators

Voltage	Weight (Kg)	Order code Form B
12V 60Hz	0.093	P2FCB340
24V 50/60Hz	0.093	P2FCB342
12V DC	0.093	P2FCB345
24V DC	0.093	P2FCB349
48V DC	0.093	P2FCB351
110V/50Hz, 120V/60Hz	0.093	P2FCB353
230V/50Hz, 230V/60Hz	0.093	P2FCB357

Spare Solenoid Nuts



Valves requiring captured exhaust should be fitted with plastic knurled nut

Order code
P2FNP

Valves with vented exhaust are fitted with diffuser plastic nut

Order Code
P2FND

Solenoid Connectors / Cable Plugs EN175301-803

	Description	Order code 22mm Industrial Form B
With standard screw	Standard IP65 without flying lead	3EV10V10
	With LED and protection 24V AC/DC	3EV10V20-24
	With LED and protection 110V AC	3EV10V20-110
	With LED and protection 230V AC	3EV10V20-230
With cable	24V AC/DC, 5m cable LED and protection IP65	3EV10V20-24L5
	110V AC/DC, 5m cable LED and protection IP65	3EV10V20-110L5
	230V AC, 5m cable LED and protection IP65	3EV10V20-230L5

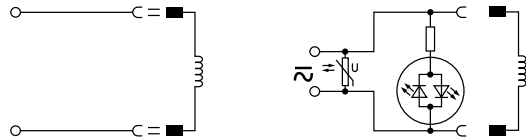

3EV10V10	3EV10V20-24	3EV10V20-24L5
	3EV10V20-110	3EV10V20-110L5
	3EV10V20-230	3EV10V20-230L5

Cable Plug Dimensions (mm)

