



aerospace
climate control
electromechanical
filtration
fluid & gas handling
hydraulics
pneumatics
process control
sealing & shielding



Pneumatic Cylinders

Series P1A - Ø10 to Ø25 mm
According to ISO 6432

Catalogue PDE2564TCUK September 2016



ENGINEERING YOUR SUCCESS.

P1A Pneumatic ISO Cylinders

Features	Air cylinder	Hydraulic cylinder	Electro mechanical actuators
Overload safe	***	***	*
Easy to limit force	***	***	*
Easy to vary speed	***	***	*
Speed	***	**	**
Reliability	***	***	***
Robustness	***	***	*
Installation cost	***	*	**
Ease of service	***	**	*
Safety in damp environments	***	***	*
Safety in explosive atmospheres	***	***	*
Safety risk with electrical installations	***	***	*
Risk of oil leak	***	*	***
Clean, hygienic	***	**	*
Standardised measurements	***	***	*
Service life	***	***	*
Hydraulic system required	***	*	***
Weight	**	**	**
Purchase price	***	**	*
Power density	**	***	*
Noise level during operation	**	***	**
High force for size	**	***	*
Positioning possibilities	*	***	***
Total energy consumption	*	**	***
Service interval	*	**	***
Compressor capacity required	*	***	***

* = good, **=average, ***=excellent



Important
 Before attempting any external or internal work on the cylinder or any connected components, make sure the cylinder is vented and disconnect the air supply in order to ensure isolation of the air supply.



Note
 All technical data in this catalogue are typical data only.
 Air quality is essential for maximum cylinder service life (see ISO 8573).



WARNING

FAILURE OR IMPROPER SELECTION OR IMPROPER USE OF THE PRODUCTS AND/OR SYSTEMS DESCRIBED HEREIN OR RELATED ITEMS CAN CAUSE DEATH, PERSONAL INJURY AND PROPERTY DAMAGE.

This document and other information from Parker Hannifin Corporation, its subsidiaries and authorized distributors provide product and/or system options for further investigation by users having technical expertise. It is important that you analyze all aspects of your application and review the information concerning the product or system in the current product catalog. Due to the variety of operating conditions and applications for these products or systems, the user, through its own analysis and testing, is solely responsible for making the final selection of the products and systems and assuring that all performance, safety and warning requirements of the application are met. The products described herein, including without limitation, product features, specifications, designs, availability and pricing, are subject to change by Parker Hannifin Corporation and its subsidiaries at any time without notice.

SALE CONDITIONS

The items described in this document are available for sale by Parker Hannifin Corporation, its subsidiaries or its authorized distributors. Any sale contract entered into by Parker will be governed by the provisions stated in Parker's standard terms and conditions of sale (copy available upon request).

Contents	Page
ISO cylinder series P1A.....	4-5
Cylinder forces.....	6
Main data	7
Working medium, air quality	7
Material specification	8
Cushioning diagram.....	8
Dimensions.....	9
Guide for selecting suitable tubing	10-11
Order key	12
Stroke length	12
Order codes single-acting.....	13
Order codes double-acting	14-15
Rod guidance modules.....	16-18
Mountings	19-22
Sensors.....	23-25
Connecting cables with one connector	26

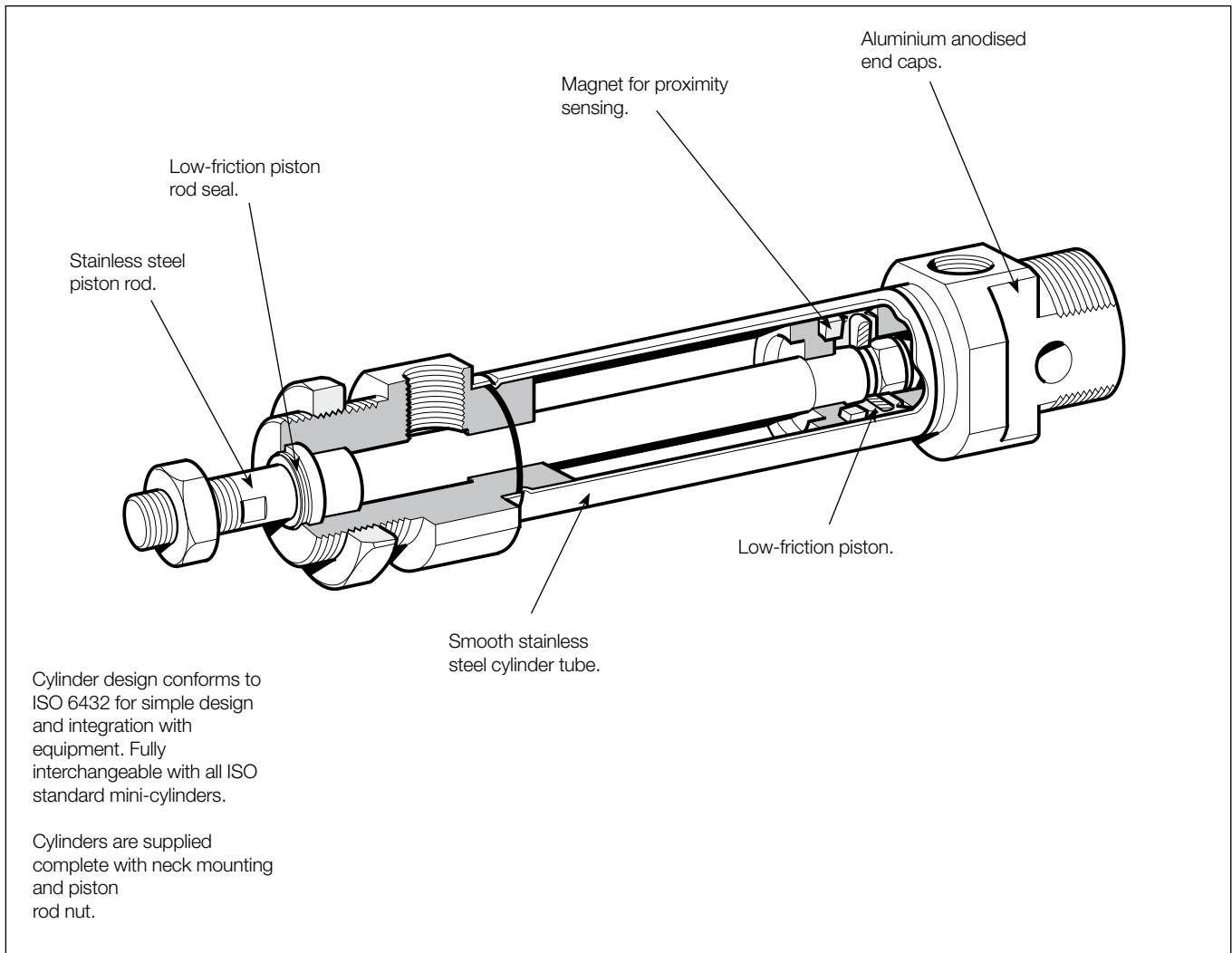

Double and single-acting versions

The P1A range of cylinders is intended for use in a wide range of applications. The cylinders are particularly suitable for lighter duties in the packaging, food and textile industries.

Hygienic design, the use of corrosion-resistant materials and initial lubrication with our food-grade grease makes the cylinders suitable for food industry applications.

Careful design and high quality manufacture throughout ensure long service life and optimum economy.

Mounting dimensions fully in accordance with ISO 6432 and CETOP RP52P greatly simplifies installation and world-wide interchangeability.

The cylinders are available in bores of 10, 12, 16, 20 and 25 mm, with stroke lengths from 10 mm to 320 mm. Single-acting cylinders with spring return in the retract direction are available in stroke lengths up to 80 mm.

Single-acting cylinders with spring return in the advance direction are available in 16 mm, 20 mm and 25 mm bore sizes and with stroke lengths up to 50 and 80 mm.

Double-acting cushioned cylinders

Adjustable pneumatic cushioning permits greater loads and higher operating speeds, making the cylinders suitable for more demanding duties.

These cylinders are available in bores of 16, 20 and 25 mm, with stroke lengths from 20 mm to 500 mm.

Options

In addition to a wide range of standard cylinders, Mini ISO cylinders are available in several standard variants, such as non-standard stroke length, extended piston rods, double piston rods, high temperature versions etc. In addition, a complete range of sensors and mountings are available.

P1A Pneumatic ISO Cylinders

Effective cushioning

The Mini ISO range is available with fixed end cushioning or with adjustable pneumatic cushioning, controlled by simple bleed screws for fine adjustment. The adjustable cushioned cylinders can be operated with higher mass loads and at higher speeds than those with fixed end cushioning, reducing overall cycle times.

Smooth external design

There are no recesses or pockets in the end covers that could trap dirt or liquid, making cleaning simple and effective.

Corrosion-resistant

Even the basic versions of the cylinders have good corrosion resistance through appropriate choice of materials and surface treatment, allowing them to be used in demanding environments.

Stainless steel versions

The Mini ISO range is also available in an all-stainless version with piston rod, barrel and end covers of stainless steel for use in particularly severe environments. See separate brochure for cylinder series P1S.

Proximity sensing

A complete range of sensors for proximity sensing is available as accessories: both reed switch and Hall effect sensors are available. They are supplied with either flying lead or cable plug connector.

Complete mounting programme

A complete ISO compatible mounting programme with surface-treated/stainless steel piston rod and cylinder mountings for both pivoted and fixed operation are available.

Variants

In addition to the basic versions, a number of standard variants of Parker Pneumatics cylinders are available to meet all demands on function and environmental adaptation:

Non-standard stroke lengths

Extended piston rods

Through piston rods

Single acting cylinder with spring return
(in the retract direction).

Single acting cylinder with spring return in the advance
direction (piston rod in extended position)

External guide, for controlled guidance of the piston rod

High-temperature cylinder versions for use in ambient
temperatures ranging from -10 °C to +150 °C for bores 12,
16, 20 and 25 mm

Cylinders with outer sealings in fluorocarbon rubber FPM

Stainless steel cylinders, see brochure for series P1S.



Double-acting, cushioned stroke



Double-acting, adjustable cushioning



Double-acting, through piston rod



Single-acting, spring return



Single-acting, spring-extended



U and H guidance modules

P1A Pneumatic ISO Cylinders

Cylinder forces, double acting variants

Cyl. bore/ pist. rod mm	Stroke	Pistonarea cm ²	Max theoretical force in N (bar)									
			1.0	2.0	3.0	4.0	5.0	6.0	7.0	8.0	9.0	10.0
10/4	+	0.8	8	16	24	31	39	47	55	63	71	79
	-	0.7	7	13	20	26	33	40	46	53	59	66
12/6	+	1.1	11	23	34	45	57	68	79	90	102	113
	-	0.8	8	17	25	34	42	51	59	68	76	85
16/6	+	2.0	20	40	60	80	100	120	141	161	181	201
	-	1.7	17	35	52	69	86	104	121	138	156	173
20/8	+	3.1	31	63	94	126	157	188	220	251	283	314
	-	2.6	26	53	79	106	132	158	185	211	238	264
25/10	+	4.9	49	98	147	196	245	295	344	393	442	491
	-	4.1	41	82	124	165	206	247	289	330	371	412

+ = Outward stroke
- = Return stroke

Note!
Select a theoretical force 50-100%
larger than the force required

Cylinder forces single acting variants

Indicated cylinder forces are theoretical and should be reduced according to the working conditions.

Order code	Theoretical piston force at 6 bar				Order code	Theoretical piston force at 6 bar			
	Nmax	Nmin	Spring retraction Nmax	Nmin		Nmax	Nmin	Spring retraction Nmax	Nmin
Single acting, spring return					Single acting, spring-extended				
P1A-S010SS-0010	38	36	10	8.5	P1A-S016TS-0010	85	84	22.3	20.2
P1A-S010SS-0015	38	36	10	7.8	P1A-S016TS-0015	86	84	22.3	19
P1A-S010SS-0025	39	36	10	6.6	P1A-S016TS-0025	88	84	22.3	17
P1A-S010SS-0040	38	34	13	9	P1A-S016TS-0040	90	84	22.3	14
P1A-S010SS-0050	39	34	13	8	P1A-S016TS-0050	91	84	22.3	12
P1A-S010SS-0080	39	34	12	7					
P1A-S012SS-0010	53	51	16	14.4	P1A-S020TS-0010	132	130	30	28
P1A-S012SS-0015	53	51	16	13.6	P1A-S020TS-0015	133	130	30	27
P1A-S012SS-0025	55	51	16	12	P1A-S020TS-0025	135	130	30	25
P1A-S012SS-0040	52	48	19	13.4	P1A-S020TS-0040	138	130	30	22
P1A-S012SS-0050	53	48	19	12	P1A-S020TS-0050	140	130	30	20
P1A-S012SS-0080	55	48	21.4	12	P1A-S020TS-0080	139	108	31	17
P1A-S016SS-0010	102	99	22.3	20.2	P1A-S025TS-0010	205	203	38.5	36
P1A-S016SS-0015	103	99	22.3	19	P1A-S025TS-0015	207	203	38.5	34.7
P1A-S016SS-0025	105	99	22.3	17	P1A-S025TS-0025	210	203	38.5	32
P1A-S016SS-0040	106	95	22.3	14	P1A-S025TS-0040	214	203	38.5	28.5
P1A-S016SS-0050	108	95	22.3	12	P1A-S025TS-0050	217	203	38.5	26
P1A-S016SS-0080	107	95	22.5	12	P1A-S025TS-0080	223	206	36	21
P1A-S020SS-0010	163	161	30	28					
P1A-S020SS-0015	164	161	30	27					
P1A-S020SS-0025	167	161	30	25					
P1A-S020SS-0040	166	159	30	22					
P1A-S020SS-0050	168	159	30	20					
P1A-S020SS-0080	170	161	29.4	18					
P1A-S025SS-0010	256	253	44.3	41.4					
P1A-S025SS-0015	258	253	44.3	40					
P1A-S025SS-0025	262	253	44.3	37					
P1A-S025SS-0040	261	250	44.3	32					
P1A-S025SS-0050	264	250	44.3	30					
P1A-S025SS-0080	264	251	44.4	30					

P1A Pneumatic ISO Cylinders

Main data

Cylinder designation	Cylinder		Piston rod			Total mass		Air	Conn. thread
	bore	area	bore	area	thread	at 0 mm stroke	addition per 10 mm stroke	consumption -	
	mm	cm ²	mm	cm ²		kg	kg	litres	
Double acting, cushioned stroke									
P1A-S010D	10	0.78	4	0.13	M4	0.04	0.003	0.0100 ¹⁾	M5
P1A-S012D	12	1.13	6	0.28	M6	0.07	0.004	0.0139 ¹⁾	M5
P1A-S016D	16	2.01	6	0.28	M6	0.09	0.005	0.0262 ¹⁾	M5
P1A-S020D	20	3.14	8	0.50	M8	0.18	0.007	0.0405 ¹⁾	G1/8
P1A-S025D	25	4.91	10	0.78	M10x1.25	0.25	0.011	0.0633 ¹⁾	G1/8
Double acting, adjustable cushioning									
P1A-S016M	16	2.01	6	0.28	M6	0.09	0.005	0.0262 ¹⁾	M5
P1A-S020M	20	3.14	8	0.50	M8	0.18	0.007	0.0405 ¹⁾	G1/8
P1A-S025M	25	4.91	10	0.78	M10x1.25	0.25	0.011	0.0633 ¹⁾	G1/8
Single acting, spring return									
P1A-S010SS	10	0.78	4	0.13	M4	0.04	0.003	0.0055 ¹⁾	M5
P1A-S012SS	12	1.13	6	0.28	M6	0.08	0.004	0.0079 ¹⁾	M5
P1A-S016SS	16	2.01	6	0.28	M6	0.10	0.005	0.0141 ¹⁾	M5
P1A-S020SS	20	3.14	8	0.50	M8	0.18	0.007	0.0220 ¹⁾	G1/8
P1A-S025SS	25	4.91	10	0.78	M10x1.25	0.26	0.011	0.0344 ¹⁾	G1/8
Single acting, spring-extended									
P1A-S016TS	16	2.01	6	0.28	M6	0.10	0.005	0.0141 ¹⁾	M5
P1A-S020TS	20	3.14	8	0.50	M8	0.18	0.007	0.0220 ¹⁾	G1/8
P1A-S025TS	25	4.91	10	0.78	M10x1.25	0.26	0.011	0.0344 ¹⁾	G1/8

1) Free air consumption per 10 mm stroke length for a double stroke at 6 bar

Working medium, air quality

Working medium Dry, filtered compressed air to ISO 8573-1 class 3.4.3.

Recommended air quality for cylinders

For best possible service life and trouble-free operation, ISO 8573-1 quality class 3.4.3 should be used. This means 5 µm filter (standard filter) dew point +3 °C for indoor operation (a lower dew point should be selected for outdoor operation) and oil concentration 1.0 mg oil/m³, which is what a standard compressor with a standard filter gives.

Additional data

Working pressure max 10 bar
Working temperature max +80 °C
min -20 °C

High-temperature version max +150 °C
min -10 °C

Prelubricated, further lubrication is not normally necessary. If additional lubrication is introduced it must be continued.

ISO 8573-1 quality classes

Quality class	Pollution		Water	Oil
	particle size (µm)	max concentration (mg/m ³)	max press dew point (°C)	max concentration (mg/m ³)
1	0.1	0.1	-70	0.01
2	1	1	-40	0.1
3	5	5	-20	1.0
4	15	8	+3	5.0
5	40	10	+7	25.
6	-	-	+10	-

P1A Pneumatic ISO Cylinders

Material specification

Piston rod	Stainless steel, DIN X 10 CrNiS 18 9
Piston rod bearing	Multilayer PTFE/steel
End covers	Anodized aluminium
O-ring, internal	Nitrile rubber, NBR
Cylinder barrel	Stainless steel, DIN X 5 CrNi 18 10
Magnet holder	Thermoplastic elastomer
Magnet	Plastic-coated magnetic material
Return spring	Surface-treated steel
Cushioning screw	Stainless steel, DIN X 10 CrNiS 18 9

Variants Mini ISO:

Standard-temperature version, type S:

Piston rod seal	Nitrile rubber, NBR
Piston complete	Nitrile rubber, NBR/steel

High-temperature version, type F:

Piston rod seal	Fluorocarbon rubber, FPM
Piston complete	HNBR/steel

Cylinders with outer sealings in fluorocarbon, type V:

Piston rod seal/ Scraper ring	Fluorocarbon rubber, FPM
----------------------------------	--------------------------

Spare part = new cylinder

Cushioning diagram

Use the diagram below to determine the necessary size of cylinder to provide the requisite cushioning performance. The maximum cushioning performance, as indicated in the diagram, is based on the following assumptions:

- Low load, i.e. low pressure drop across the piston
- Steady-state piston speed
- Correctly adjusted cushioning screw

The load is the sum of the internal and external friction, together with any gravity forces. At high relative loading it is recommended that, for a given speed, the load should be reduced by a factor of 2.5, or that, for a given mass, the speed should be reduced by a factor of 1.5. These factors apply in relation to the maximum performance as shown in the diagram.

Fixed end-cushioning
Speed [m/s]

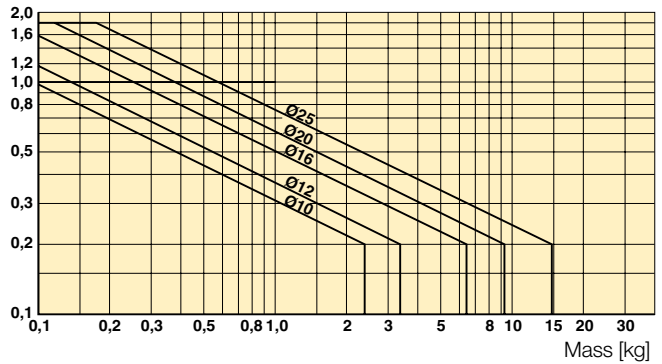

Adjustable pneumatic end-cushioning
Speed [m/s]

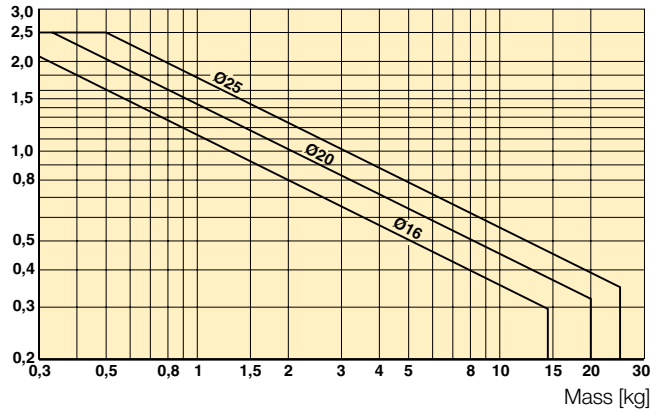

P1A Pneumatic ISO Cylinders

Dimensions

Double and single acting

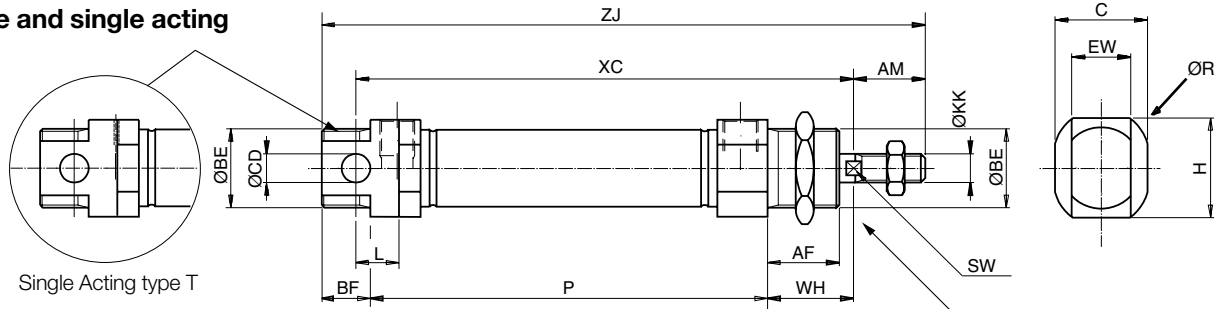

Through piston rod

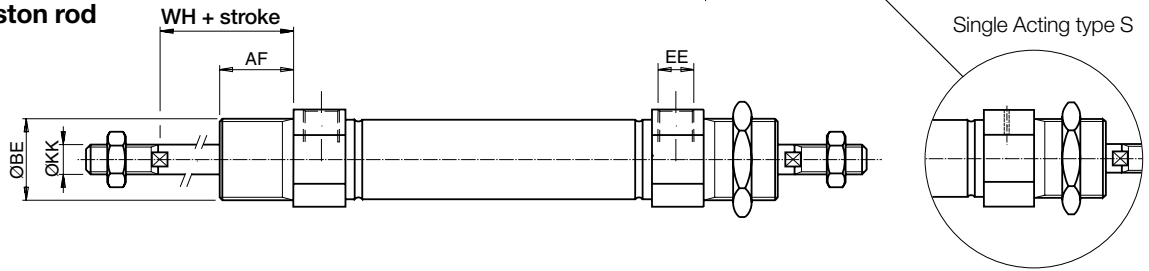

Cylinder bore mm	EE	Ø BE mm	Ø CD H9 mm	BF	L	AF	WH ±1,2	AM 0/-2	Ø KK	SW	C	EW	H	Ø R
10	M5	M12x1,25	4	10	6	12	16	12	M4	-	13,0	8	13,5	16,0
12	M5	M16x1,50	6	13	9	18	22	16	M6	5	17,8	12	17,4	20,0
16 ¹⁾	M5	M16x1,50	6	13	9	18	22	16	M6	5	23,8	12	23,4	27,0
16 ²⁾	M5	M16x1,50	6	13	9	18	22	16	M6	5	17,8	12	17,5	20,0
20 ¹⁾	G1/8	M22x1,50	8	14	12	20	24	20	M8	7	23,9	16	23,9	28,0
20 ²⁾	G1/8	M22x1,50	8	14	12	20	24	20	M8	7	23,8	16	23,4	27,0
25 ¹⁾	G1/8	M22x1,50	8	14	12	22	28	22	M10x1,25	9	26,9	16	26,9	31,5
25 ²⁾	G1/8	M22x1,50	8	14	12	22	28	22	M10x1,25	9	26,8	16	26,6	31,0

1) SS / TS single acting 2) DS / MS double acting

Double acting cylinders

Cylinder bore mm	ZJ	XC	P
10	84 + stroke	64 + stroke	46 + stroke
12	99 + stroke	75 + stroke	48 + stroke
16 ²⁾	104 + stroke	82 + stroke	53 + stroke
20 ²⁾	125 + stroke	95 + stroke	67 + stroke
25 ²⁾	132 + stroke	104 + stroke	68 + stroke

Single-acting, spring return, type S

Stroke/ Cylinder bore mm	10 XC	15 XC	25 XC	40 XC	50 XC	80 XC	10 ZJ	15 ZJ	25 ZJ	40 ZJ	50 ZJ	80 ZJ	10 P	15 P	25 P	40 P	50 P	80 P
10	74	79	89	126	136	174	94	99	109	146	156	194	56	61	71	108	118	156
12	85	90	100	132	142	185	109	114	124	156	166	209	58	63	73	105	115	158
16	92	97	107	122	132	184	114	119	129	144	154	206	63	68	78	93	103	155
20	105	110	120	135	145	191	135	140	150	165	175	221	77	82	92	107	117	163
25	114	119	129	144	154	201	142	147	157	172	182	229	78	83	93	108	118	165

Single-acting, spring-extended, type T

Stroke/ Cylinder bore mm	10 XC ³⁾	15 XC ³⁾	25 XC ³⁾	40 XC ³⁾	50 XC ³⁾	80 XC ³⁾	10 ZJ ³⁾	15 ZJ ³⁾	25 ZJ ³⁾	40 ZJ ³⁾	50 ZJ ³⁾	80 ZJ ³⁾	10 P	15 P	25 P	40 P	50 P	80 P
16	107	112	122	137	147	-	129	134	144	159	169	-	78	83	93	108	118	-
20	120	125	135	150	160	195	150	155	165	180	190	225	92	97	107	122	132	167
25	129	134	144	159	169	205	157	162	172	187	197	233	93	98	108	123	133	169

3) With piston rod retracted, as shown in the dimension drawing
 Length tolerances ±1 mm
 Stroke length tolerances +1.5/0 mm

Cylinders are supplied complete with mounting and adjusting nuts.
 Cylinders with through piston rod are supplied complete with two adjusting nuts and one mounting nut.

Guide for selecting suitable tubing

The selection of the correct size of tubing is often based on experience, with no great thought to optimizing energy efficiency and cylinder velocity. This is usually acceptable, but making a rough calculation can result in worthwhile economic gains.

The following is the basic principle:

1. The primary line to the working valve could be over sized (this does not cause any extra air consumption and consequently does not create any extra costs in operation).
2. The tubes between the valve and the cylinder should, however, be optimized according to the principle that an insufficient bore throttles the flow and thus limits the cylinder speed, while an oversized pipe creates a dead volume which increases the air consumption and filling time.

The chart below is intended to help when selecting the correct size of tube to use between the valve and the cylinder.

The following prerequisites apply:

The cylinder load should be about 50% of the theoretical force (= normal load). A lower load gives a higher velocity and vice versa. The tube size is selected as a function of the cylinder bore, the desired cylinder velocity and the tube length between the valve and the cylinder.

If you want to use the capacity of the valve to its maximum, and obtain maximum speed, the tubing should be chosen so that they at least correspond with the equivalent restriction diameter (see description below), so that the tubing does not restrict the total flow. This means that a short tubing must have at least the equivalent restriction diameter. If the tubing is longer, choose it from the table below. Straight fittings should be chosen for highest flow rates. (Elbow and banjo fittings cause restriction.)

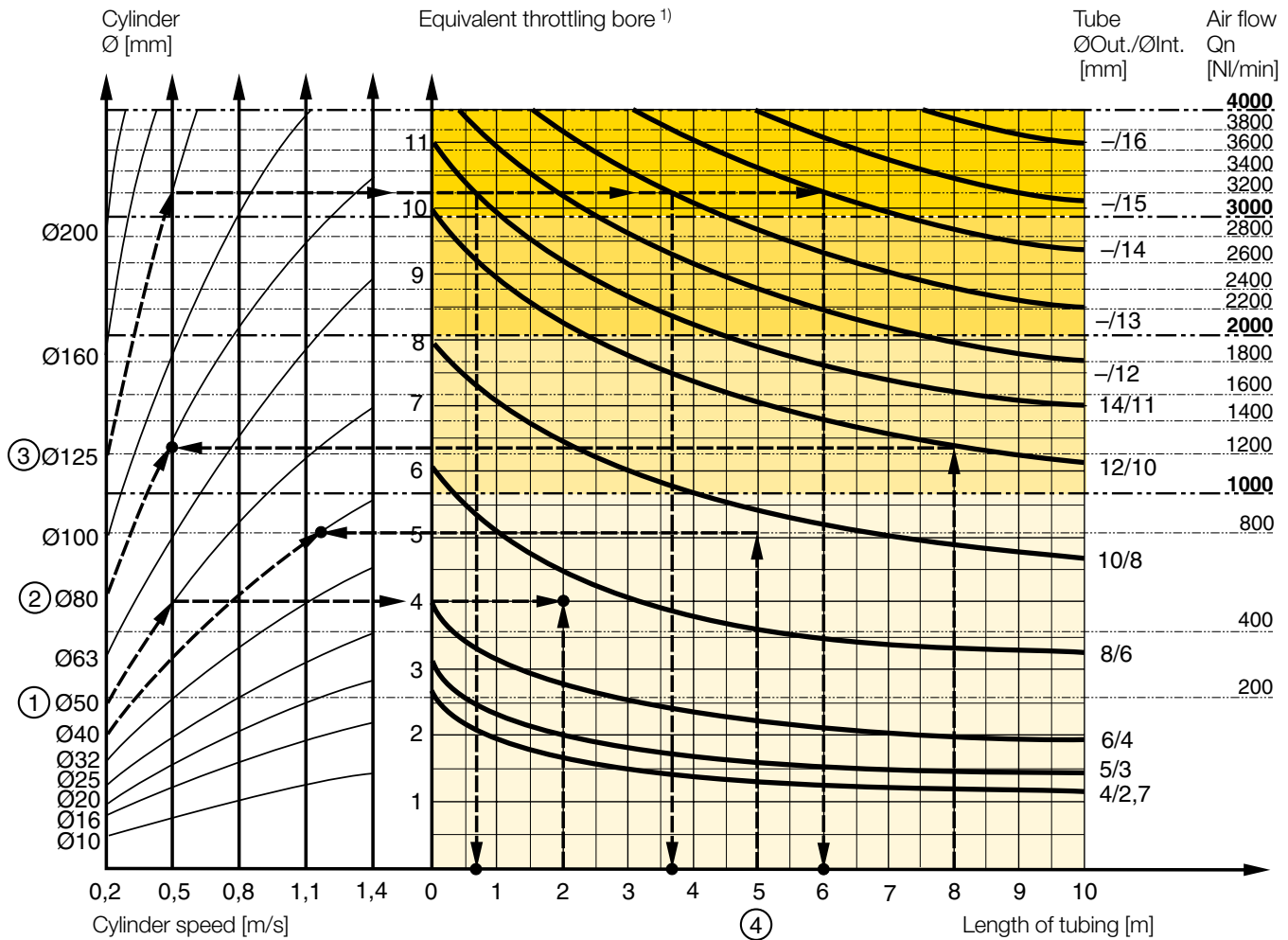

- 1) The “equivalent throttling bore“ is a long throttle (for example a tube) or a series of throttles (for example, through a valve) converted to a short throttle which gives a corresponding flow rate. This should not be confused with the “orifice“ which is sometimes specified for valves. The value for the orifice does not normally take account of the fact that the valve contains a number of throttles.
- 2) Qn is a measure of the valve flow capacity, with flow measured in litre per minute (l/min) at 6 bar(e) supply pressure and 1 bar pressure drop across the valve.

P1A Pneumatic ISO Cylinders

Example ① : Which tube diameter should be used?

A 50 mm bore cylinder is to be operated at 0.5 m/s. The tube length between the valve and cylinder is 2 m. In the diagram we follow the line from 50 mm bore to 0.5 m/s and get an “equivalent throttling bore” of approximately 4 mm. We continue out to the right in the chart and intersect the line for a 2 m tube between the curves for 4 mm (6/4 tube) and 6 mm (8/6 tube). This means that a 6/4 tube throttles the velocity somewhat, while an 8/6 tube is a little too large. We select the 8/6 tube to obtain full cylinder velocity.

Example ②: What cylinder velocity will be obtained?

A 80 mm bore cylinder will be used, connected by 8 m 12/10 tube to a P2L-B valve. What cylinder velocity will we get? We refer to the diagram and follow the line from 8 mm tube length up to the curve for 12/10 tube. From there, we go horizontally to the curve for the Ø80 cylinder. We find that the velocity will be about 0.5 m/s.

Example ③: What is the minimum inner diameter and maximum length of tube?

For an application a 125 mm bore cylinder will be used. Maximum velocity of piston rod is 0.5 m/s. The cylinder will be controlled by a P2L-D valve. What diameter of tube can be used and what is maximum length of tube.

We refer to the diagram. We start at the left side of the diagram cylinder Ø125. We follow the line until the intersection with the velocity line of 0.5 m/s. From here we draw a horizontal line in the diagram. This line shows us we need an equivalent throttling bore of approximately 10 mm. Following this line horizontally we cross a few intersections. These intersections shows us the minimum inner diameter (rightside diagram) in combination with the maximum length of tube (bottomside diagram).

For example:

Intersection one: When a tube (14/11) will be used, the maximum length of tube is 0.7 meter.

Intersection two: When a tube (—/13) will be used, the maximum length of tube is 3.7 meter.

Intersection three: When a tube (—/14) will be used, the maximum length of tube is 6 meter.

Example ④ : Determining tube size and cylinder velocity with a particular cylinder and valve?

For an application using a 40 mm bore cylinder with a valve with $Q_n=800$ NI/min. The distance between the cylinder and valve has been set to 5 m.

Tube dimension: What tube bore should be selected to obtain the maximum cylinder velocity? Start at pipe length 5 m, follow the line up to the intersection with 800 NI/min. Select the next largest tube diameter, in this case Ø10/8 mm.

Cylinder velocity: What maximum cylinder velocity will be obtained? Follow the line for 800 NI/min to the left until it intersects with the line for the Ø40 mm cylinder. In this example, the speed is just above 1.1 m/s.







Valve series with respective flows in NI/minute

Valve series	Qn in NI/Min
Valvetronic Solstar	33
Interface PS1	100
Adex A05	173
Moduflex size 1, (2 x 3/2)	220
Valvetronic PVL-B 5/3 closed centre, 6 mm push in	290
Moduflex size 1, (4/2)	320
B43 Manual and mechanical	340
Valvetronic PVL-B 2 x 2/3, 6 mm push in	350
Valvetronic PVL-B 5/3 closed centre, G1/8	370
Compact Isomax DX02	385
Valvetronic PVL-B 2 x 3/2 G1/8	440
Valvetronic PVL-B 5/2, 6 mm push in	450
Valvetronic PVL-B 5/3 vented centre, 6 mm push in	450
Moduflex size 2, (2 x 3/2)	450
Flowstar P2V-A	520
Valvetronic PVL-B 5/3 vented centre, G1/8	540
Valvetronic PVL-B 5/2, G1/8	540
Valvetronic PVL-C 2 x 3/2, 8 mm push in	540
Adex A12	560
Valvetronic PVL-C 2 x 3/2 G1/8	570
Compact Isomax DX01	585
VIKING Xtreme P2LAX	660
Valvetronic PVL-C 5/3 closed centre, 8 mm push in	700
Valvetronic PVL-C 5/3 vented centre, G1/4	700
B3-Series	780
Valvetronic PVL-C 5/3 closed centre, G1/4	780
Moduflex size 2, (4/2)	800
Valvetronic PVL-C 5/2, 8 mm push in	840
Valvetronic PVL-C 5/3 vented centre, 8 mm push in	840
Valvetronic PVL-C 5/2, G1/4	840
Flowstar P2V-B	1090
ISOMAX DX1	1150
B53 Manual and mechanical	1160
B4-Series	1170
VIKING Xtreme P2LBX	1290
B5-Series, G1/4	1440
Airline Isolator Valve VE22/23	1470
ISOMAX DX2	2330
VIKING Xtreme P2LCX, G3/8	2460
VIKING Xtreme P2LDX, G1/2	2660
ISOMAX DX3	4050
Airline Isolator Valve VE42/43	5520
Airline Isolator Valve VE82/83	13680

Order key

P1A-S	016	M	S	-	0025
--------------	------------	----------	----------	----------	-------------

Cylinder bore mm
010
012
016
020
025

Cylinder type / function
M  Double-acting, adjustable cushioning. Ø16-25 mm. Not for sealing material type F.
D  Double-acting, non-adjustable cushioning, Ø10 - Ø25
F  Double-acting, adjustable cushioning, thru-rod, Ø16-25 mm. Not for sealing material type F.
K  Double-acting, non-adjustable cushioning, thru-rod, Ø10 - Ø25
S  Single-acting, non-adjustable cushioning, spring return for retract stroke, Ø10-25 mm. Not for sealing material type F.
T  Single-acting, non-adjustable cushioning, spring return for advance stroke, Ø16-25 mm. Not for sealing material type F.

Stroke length, mm
E.g. 0025 = 25 mm For standard stroke length and max length see table below.

Sealing material
S Standard, -20 °C to +80 °C. Magnetic piston
F  High temperature, Ø12, 16, 20 and 25 mm -10 °C to +150 °C. Non-magnetic piston
V External seals of fluorinated rubber. -20 °C to +80 °C. Magnetic piston

Note: P1A Series also available with end caps made of stainless steel - replace P1A with P1S in the order code key.

Stroke length

Cylinder designation	Cylinder bore	● Standard stroke length in mm										■ Non standard stroke length									
		10	15	20	25*	30	40	50*	80*	100*	125*	160*	200*	250*	320*	400*	500*				
Double acting with fixed end-cushioning:																					
P1A-S010D	10	●	●	●	●	●	●	●	●	●	●	●	●	●	●	●	●				
P1A-S012D	12	●	●	●	●	●	●	●	●	●	●	●	●	●	●	●	●				
P1A-S016D	16	●	●	●	●	●	●	●	●	●	●	●	●	●	●	●	●				
P1A-S020D	20	●	●	●	●	●	●	●	●	●	●	●	●	●	●	●	●				
P1A-S025D	25	●	●	●	●	●	●	●	●	●	●	●	●	●	●	●	●				
Double acting with adjustable end-cushioning:																					
P1A-S016M	16	●	●	●	●	●	●	●	●	●	●	●	●	●	●	●	●				
P1A-S020M	20	●	●	●	●	●	●	●	●	●	●	●	●	●	●	●	●				
P1A-S025M	25	●	●	●	●	●	●	●	●	●	●	●	●	●	●	●	●				
Single acting, spring return:																					
P1A-S010SS	10	●	●	●	●	●	●	●	●	●	●	●	●	●	●	●	●				
P1A-S012SS	12	●	●	●	●	●	●	●	●	●	●	●	●	●	●	●	●				
P1A-S016SS	16	●	●	●	●	●	●	●	●	●	●	●	●	●	●	●	●				
P1A-S020SS	20	●	●	●	●	●	●	●	●	●	●	●	●	●	●	●	●				
P1A-S025SS	25	●	●	●	●	●	●	●	●	●	●	●	●	●	●	●	●				
Single acting, spring-extended:																					
P1A-S016TS	16	●	●	●	●	●	●	●	●	●	●	●	●	●	●	●	●				
P1A-S020TS	20	●	●	●	●	●	●	●	●	●	●	●	●	●	●	●	●				
P1A-S025TS	25	●	●	●	●	●	●	●	●	●	●	●	●	●	●	●	●				

* Standard stroke lengths in mm according to ISO 4393
 ** Max stroke 1000 mm

P1A Pneumatic ISO Cylinders

Data

Working pressure	max. 10 bar
Working temperature	max. +80 °C min. -20 °C



Single-acting spring return Fixed end cushioning

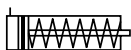

Cyl.bore mm	Stroke mm	Order code
10 Conn. M5	10	P1A-S010SS-0010
	15	P1A-S010SS-0015
	25	P1A-S010SS-0025
	40	P1A-S010SS-0040
	50	P1A-S010SS-0050
	80	P1A-S010SS-0080
12 Conn. M5	10	P1A-S012SS-0010
	15	P1A-S012SS-0015
	25	P1A-S012SS-0025
	40	P1A-S012SS-0040
	50	P1A-S012SS-0050
	80	P1A-S012SS-0080
16 Conn. M5	10	P1A-S016SS-0010
	15	P1A-S016SS-0015
	25	P1A-S016SS-0025
	40	P1A-S016SS-0040
	50	P1A-S016SS-0050
	80	P1A-S016SS-0080
20 Conn. G1/8	10	P1A-S020SS-0010
	15	P1A-S020SS-0015
	25	P1A-S020SS-0025
	40	P1A-S020SS-0040
	50	P1A-S020SS-0050
	80	P1A-S020SS-0080
25 Conn. G1/8	10	P1A-S025SS-0010
	15	P1A-S025SS-0015
	25	P1A-S025SS-0025
	40	P1A-S025SS-0040
	50	P1A-S025SS-0050
	80	P1A-S025SS-0080

Cylinders are supplied complete with neck mounting and piston rod nuts.



Single-acting spring extended Fixed end cushioning



Cyl.bore mm	Stroke mm	Order code
16 Conn. M5	10	P1A-S016TS-0010
	15	P1A-S016TS-0015
	25	P1A-S016TS-0025
	40	P1A-S016TS-0040
	50	P1A-S016TS-0050
	80	P1A-S016TS-0080
20 Conn. G1/8	10	P1A-S020TS-0010
	15	P1A-S020TS-0015
	25	P1A-S020TS-0025
	40	P1A-S020TS-0040
	50	P1A-S020TS-0050
	80	P1A-S020TS-0080
25 Conn. G1/8	10	P1A-S025TS-0010
	15	P1A-S025TS-0015
	25	P1A-S025TS-0025
	40	P1A-S025TS-0040
	50	P1A-S025TS-0050
	80	P1A-S025TS-0080

Cylinders are supplied complete with neck mounting and piston rod nuts.

P1A Pneumatic ISO Cylinders

Data

Working pressure max. 10 bar
 Working temperature max. +80 °C
 min. -20 °C



Double-acting Fixed end cushioning

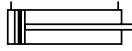

Cyl.bore mm	Stroke mm	Order code
10 Conn. M5	10	P1A-S010DS-0010
	15	P1A-S010DS-0015
	20	P1A-S010DS-0020
	25	P1A-S010DS-0025
	30	P1A-S010DS-0030
	40	P1A-S010DS-0040
	50	P1A-S010DS-0050
	80	P1A-S010DS-0080
	100	P1A-S010DS-0100
	125	P1A-S010DS-0125
Max stroke 500 mm		
12 Conn. M5	10	P1A-S012DS-0010
	15	P1A-S012DS-0015
	20	P1A-S012DS-0020
	25	P1A-S012DS-0025
	30	P1A-S012DS-0030
	40	P1A-S012DS-0040
	50	P1A-S012DS-0050
	80	P1A-S012DS-0080
	100	P1A-S012DS-0100
	125	P1A-S012DS-0125
160	P1A-S012DS-0160	
200	P1A-S012DS-0200	
Max stroke 500 mm		
16 Conn. M5	10	P1A-S016DS-0010
	15	P1A-S016DS-0015
	20	P1A-S016DS-0020
	25	P1A-S016DS-0025
	30	P1A-S016DS-0030
	40	P1A-S016DS-0040
	50	P1A-S016DS-0050
	80	P1A-S016DS-0080
	100	P1A-S016DS-0100
	125	P1A-S016DS-0125
160	P1A-S016DS-0160	
200	P1A-S016DS-0200	
Max stroke 500 mm		

Fixed end cushioning

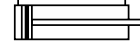

Cyl.bore mm	Stroke mm	Order code
20 Conn. G1/8	10	P1A-S020DS-0010
	15	P1A-S020DS-0015
	20	P1A-S020DS-0020
	25	P1A-S020DS-0025
	30	P1A-S020DS-0030
	40	P1A-S020DS-0040
	50	P1A-S020DS-0050
	80	P1A-S020DS-0080
	100	P1A-S020DS-0100
	125	P1A-S020DS-0125
160	P1A-S020DS-0160	
200	P1A-S020DS-0200	
250	P1A-S020DS-0250	
320	P1A-S020DS-0320	
Max stroke 1000 mm		
25 Conn. G1/8	10	P1A-S025DS-0010
	15	P1A-S025DS-0015
	20	P1A-S025DS-0020
	25	P1A-S025DS-0025
	30	P1A-S025DS-0030
	40	P1A-S025DS-0040
	50	P1A-S025DS-0050
	80	P1A-S025DS-0080
	100	P1A-S025DS-0100
	125	P1A-S025DS-0125
160	P1A-S025DS-0160	
200	P1A-S025DS-0200	
250	P1A-S025DS-0250	
320	P1A-S025DS-0320	
Max stroke 1000 mm		

Cylinders are supplied complete with neck mounting and piston rod nuts.
 Cylinders with Through piston rods are supplied with two piston rod nuts
 and one neck mounting nut.

P1A Pneumatic ISO Cylinders

Data

Working pressure max. 10 bar
 Working temperature max. +80 °C
 min. -20 °C



Double-acting

Adjustable cushioning

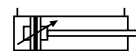
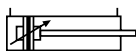

Cyl.bore mm	Stroke mm	Order code	
16 Conn. M5	20	P1A-S016MS-0020	
	25	P1A-S016MS-0025	
	30	P1A-S016MS-0030	
	40	P1A-S016MS-0040	
	50	P1A-S016MS-0050	
	80	P1A-S016MS-0080	
	100	P1A-S016MS-0100	
	125	P1A-S016MS-0125	
	160	P1A-S016MS-0160	
	200	P1A-S016MS-0200	
	250	P1A-S016MS-0250	
	320	P1A-S016MS-0320	
	400	P1A-S016MS-0400	
	Max stroke 500 mm	500	P1A-S016MS-0500
	20 Conn. G1/8	20	P1A-S020MS-0020
25		P1A-S020MS-0025	
30		P1A-S020MS-0030	
40		P1A-S020MS-0040	
50		P1A-S020MS-0050	
80		P1A-S020MS-0080	
100		P1A-S020MS-0100	
125		P1A-S020MS-0125	
160		P1A-S020MS-0160	
200		P1A-S020MS-0200	
250		P1A-S020MS-0250	
320		P1A-S020MS-0320	
400		P1A-S020MS-0400	
Max stroke 1000 mm		500	P1A-S020MS-0500

Cyl.bore mm	Stroke mm	Order code	
25 Conn. G1/8	20	P1A-S025MS-0020	
	25	P1A-S025MS-0025	
	30	P1A-S025MS-0030	
	40	P1A-S025MS-0040	
	50	P1A-S025MS-0050	
	80	P1A-S025MS-0080	
	100	P1A-S025MS-0100	
	125	P1A-S025MS-0125	
	160	P1A-S025MS-0160	
	200	P1A-S025MS-0200	
	250	P1A-S025MS-0250	
	320	P1A-S025MS-0320	
	400	P1A-S025MS-0400	
	Max stroke 1000 mm	500	P1A-S025MS-0500

Cylinders are supplied complete with neck mounting and piston rod nuts. Cylinders with Through piston rods are supplied with two piston rod nuts and one neck mounting nut.

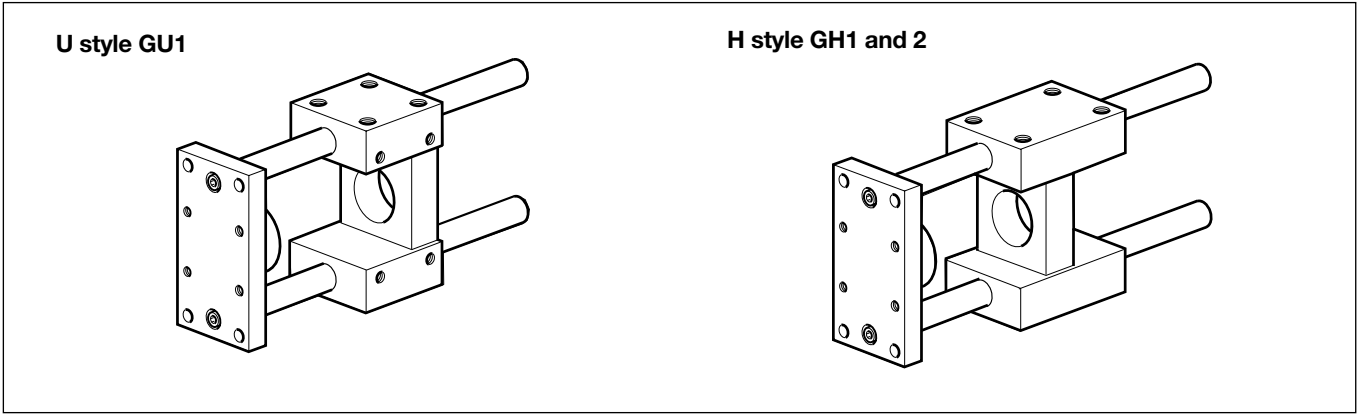

P1A with rod guidance modules

The P1A series cylinders can be equipped with an external guiding device to prevent the piston rod from turning. When fitted the guide provides a guided piston movement enabling the cylinder to resist turning moments on the piston rod, as well as greater transverse forces. Rod guides are available with plain bearings as U style or linear ball bearings as H style.

The bracket, which has pre-drilled mounting holes, is connected to the piston rod by means of a flexocoupling, which prevents the build-up of stress in the cylinder.

P1A cylinders with guiding device are available with bores from 12 to 25 mm, and stroke lengths up to 250 mm. Separate guiding device kits can be supplied on request according to the order key below.

Technical data

Working temperature -20 °C to +80 °C

Material specifications, guidance modules

Body	Anodised aluminium
Guide bars, H style	Hardened stainless steel
Front plate	Anodised aluminium
Guide bars, U style	Stainless steel
Front plate	Zinc-plated steel
Plain bearings	Bronze

Other data as standard cylinder.

Order key

P1A - 4DRH - XXXX

Cylinder version		Bore size mm		Guide module type		Stroke length (mm)	
A	Mini ISO cylinders	D	12, 16	H	H style, ball bearings	Same as for the cylinder	
		H	20	K	U style, plain bearings		
		J	25				

Transverse force as a function of load distance

S = Load centre line
X = Load distance (mm)

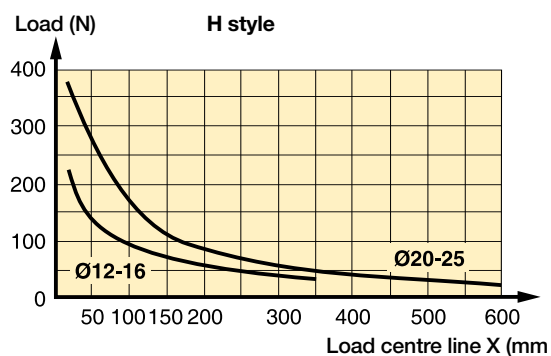
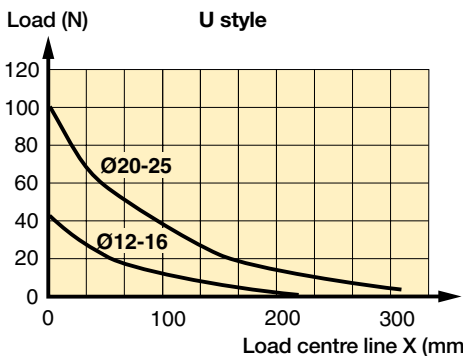
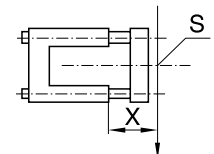

Dimensions (mm)

U style guidance modules. plain bearings

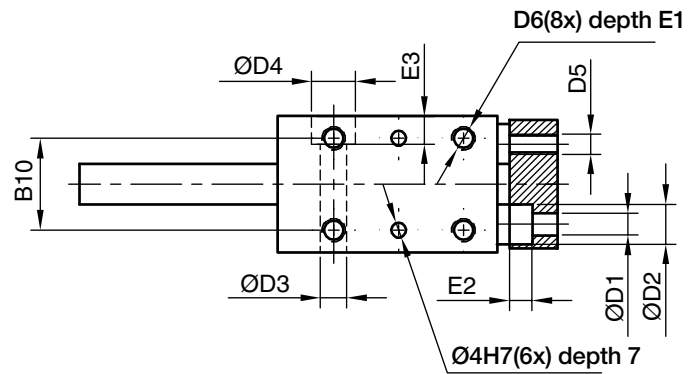
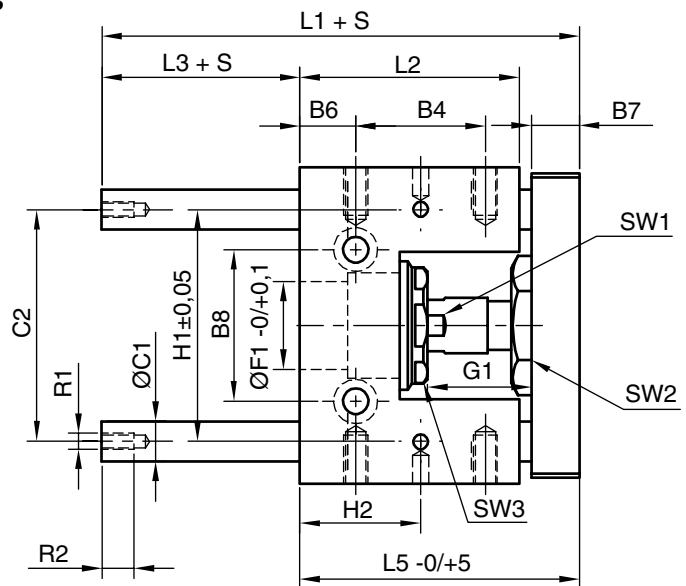
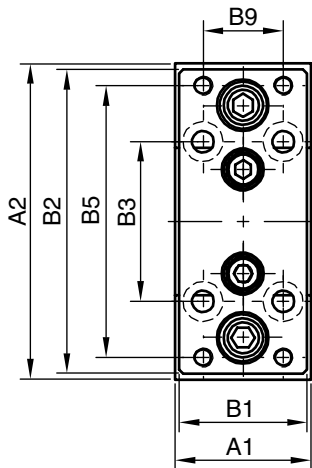

Cyl. bore	A1	A2	B1	B2	B3	B4	B5	B6	B7	B8	B9	B10	C1	C2	D1	D2	D3	D4
12/16	30	65	27	63	32	25,0	54	7,5	10	24	15	22	8	46	4,5	8,0	5,5	-
20	34	79	32	76	40	32,5	68	14,0	12	38	20	23	10	58	5,5	10,5	6,5	11
25	34	79	32	76	40	32,5	68	14,0	12	38	20	23	10	58	5,5	10,5	6,5	11

Cyl. bore	D5	D6	E1	E2	E3	F1	G1	L1	L2	L3	L5	SW1	SW2	SW3	R1	R2	H1	H2
12/16	M4	M4	8	4,6	-	16	16	69	39	17	52	22	8	19	M4	8	46	20
20	M5	M6	12	5,6	7	22	30	85	55	15	70	30	13	27	M6	11	58	30
25	M5	M6	12	5,6	7	22	23	85	55	15	70	30	13	27	M6	11	58	30

Cyl. bore	Weight stroke 0 mm kg	Additional weight per 10 mm stroke kg
12/16	0,26	0,0078
20	0,47	0,1233
25	0,47	0,1233

S = Stroke

Dimensions (mm)

H style guidance modules. plain bearings

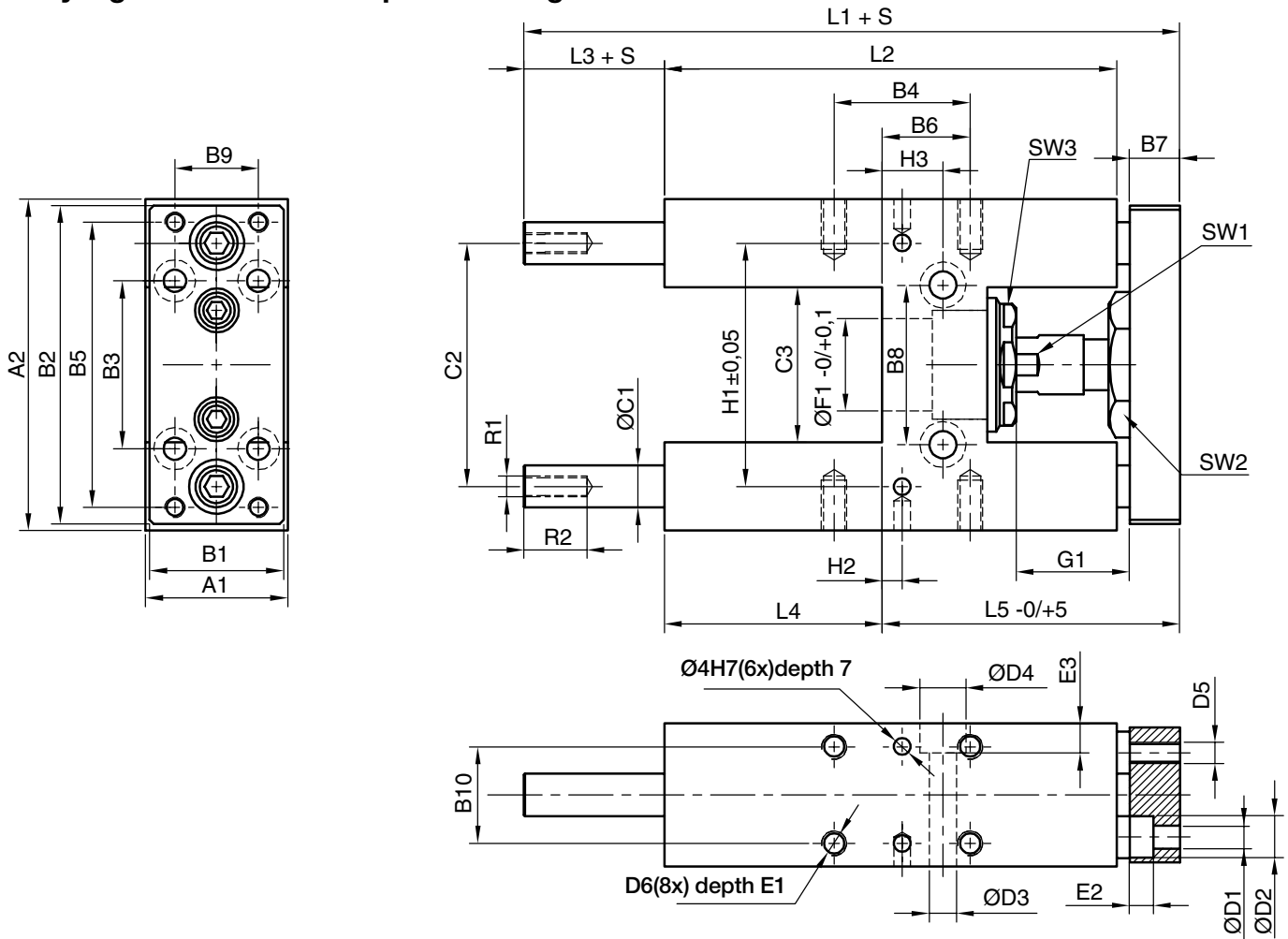

Cyl. bore	A1	A2	B1	B2	B3	B4	B5	B6	B7	B8	B9	B10	C1	C2	C3	D1	D2	D3
12/16	30	65	27	63	32	32,5	54	13	10	24	15	22	8	46	27	4,5	8,0	5,5
20	34	79	32	76	40	32,5	68	21	12	38	20	23	10	58	37	5,5	10,5	6,5
25	34	79	32	76	40	32,5	68	21	12	38	20	23	10	58	37	5,5	10,5	6,5

Cyl. bore	D4	D5	D6	E1	E2	E3	F1	G1	L1	L2	L3	L4	L5	SW1	SW2	SW3	R1	R2
12/16	9	M4	M4	8	4,6	6	16	16	130	75	44	35	51	22	8	19	M4	8
20	11	M5	M6	12	5,6	7	22	30	160	108	43	52	65	30	13	27	M6	11
25	11	M5	M6	12	5,6	7	22	23	160	108	43	52	65	30	13	27	M6	11

Cyl. bore	H1	H2	H3
12/16	46	-3,25	8,5
20	58	4,75	15,0
25	58	4,75	15,0

Cyl. bore	Weight stroke 0 mm kg	Additional weight per 10 mm stroke kg
12/16	0,43	0,0078
20	0,77	0,1233
25	0,77	0,1233

S = Stroke

Cylinder mountings

Type	Description	Cyl. bore Ø mm	Weight kg	Order code
------	-------------	-------------------	--------------	------------

Flange-MF8

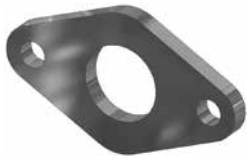

Intended for fixed attachment of the cylinder. The flange is designed for mounting on the front or rear end-covers.

Material:
Surface-treated steel

10
12-16
20-25

0,012
0,025
0,045

P1A-4CMB
P1A-4DMB
P1A-4HMB

Stainless Flange-MF8

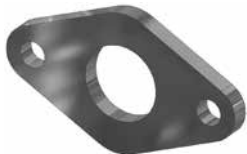

Intended for fixed attachment of the cylinder. The flange is designed for mounting on the front or rear end-covers.

Material:
Stainless steel, DIN X 10 CrNiS 18 9

10
12-16
20-25

0,012
0,025
0,045

P1S-4CMB
P1S-4DMB
P1S-4HMB

Cylinder Ø mm	A mm	B mm	C mm	D mm	E mm	F mm
10	4.5	30	40	22	3	13
12-16	5.5	40	52	30	4	18
20	6.5	50	66	40	5	19
25	6.5	50	66	40	5	23

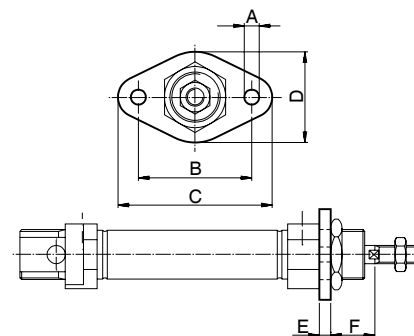

Foot-MS3



Intended for fixed attachment of the cylinder. The bracket is designed for mounting on the front or rear end covers.

Material:
Surface-treated steel

10
12-16
20-25

0,020
0,040
0,080

P1A-4CMF
P1A-4DMF
P1A-4HMF

Stainless Foot-MS3



Intended for fixed attachment of the cylinder. The bracket is designed for mounting on the front or rear end covers.

Material:
Stainless steel, DIN X 10 CrNiS 18 9

10
12-16
20-25

0,020
0,040
0,080

P1S-4CMF
P1S-4DMF
P1S-4HMF

Cylinder Ø mm	A mm	B mm	C mm	D mm	E mm	F mm	G mm	H mm	I mm
10	4.5	16	25	35	3	24	26.0	16	11
12-16	5.5	20	32	42	4	32	32.5	20	14
20	6.6	25	40	54	5	36	45.0	25	17
25	6.6	25	40	54	5	40	45.0	25	17

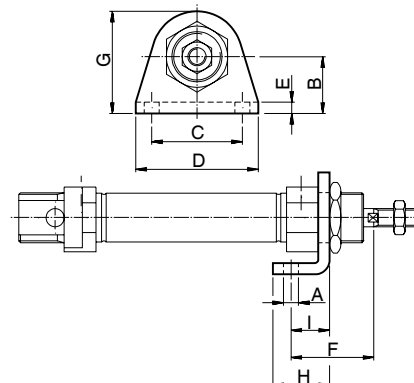

Cylinder mountings

Type	Description	Cyl. bore Ø mm	Weight kg	Order code
Cover trunnion	Intended for articulated mounting of the cylinder. The flange is designed for mounting on the front or rear end covers. Material: Surface-treated steel	10	0.014	P1A-4CMJZ P1A-4DMJZ P1A-4HMJZ
		12-16	0.033	
		20-25	0.037	

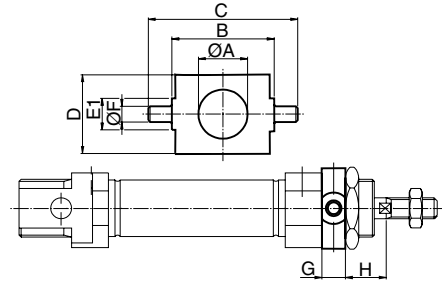
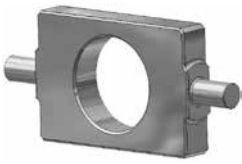

Cylinder Ø mm	A mm	B h14 mm	C mm	D mm	E1 mm	F e9 mm	G mm	H mm
10	12.5	26	38	20	9	4	6	10
12-16	16.5	38	58	25	13	6	8	14
20	22.5	46	66	30	13	6	8	16
25	22.5	46	66	30	13	6	8	20

Stainless Cover trunnion	Intended for articulated mounting of the cylinder. The flange is designed for mounting on the front or rear end covers. Material: Stainless steel, DIN X 10 CrNiS 18 9	10	0.014	P1A-4CMJ P1A-4DMJ P1A-4HMJ
		12-16	0.033	
		20-25	0.037	

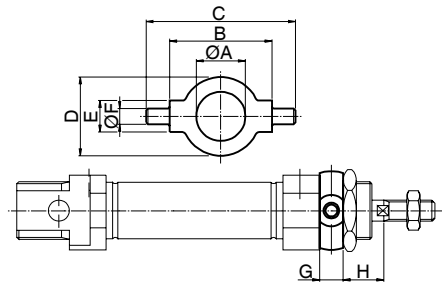

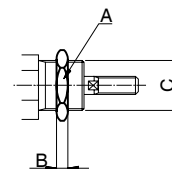

Cylinder Ø mm	A mm	B h14 mm	C mm	D mm	E mm	F e9 mm	G mm	H mm
10	12.5	26	38	20	8	4	6	10
12-16	16.5	38	58	25	10	6	8	14
20	22.5	46	66	30	10	6	8	16
25	22.5	46	66	30	10	6	8	20

Stainless Neck nut MR3	Intended for fixed mounting of the cylinder. Cylinders are supplied complete with one mounting nut. Material: Stainless steel, DIN X 5 CrNi 18 10	10	0.009	9126725405 9126725406 9126725407
		12-16	0.018	
		20-25	0.042	



Cylinder Ø mm	A mm	B mm	C
10	17	5	M12x1.25
12-16	24	8	M16x1.50
20-25	27	5	M22x1.50

Cylinder mountings

Type	Description	Cyl. bore Ø mm	Weight kg	Order code
 Clevis bracket AB3	Intended for articulated mounting of the cylinder. Supplied with shaft for mounting on the rear end cover. Material: Bracket: surface-treated steel, black Pin: surface hardened steel Circlips: according to DIN 471: Stainless steel	10	0.020	P1A-4CMT P1A-4DMT P1A-4HMT
		12-16	0.040	
		20-25	0.080	
 Stainless Clevis bracket AB3	Intended for articulated mounting of the cylinder. Supplied with shaft for mounting on the rear end cover. Material: Bracket: stainless steel, DIN X 5 CrNi 18 10 Pin: tempered stainless steel, DIN X 20 Cr 13 Locking rings: stainless steel, DIN X 5 CrNi 18 10	10	0.020	P1S-4CMT P1S-4DMT P1S-4HMT
		12-16	0.040	
		20-25	0.080	

Cylinder Ø mm	A mm	B mm	C mm	D mm	E mm	F mm	G mm	H mm	I °	J °
10	4.5	13	8.1	24	12.5	20	65.3	5	160	17
12	5.5	18	12.1	27	15.0	25	73.0	7	170	15
16	5.5	18	12.1	27	15.0	25	80.0	7	170	15
20	6.6	24	16.1	30	20.0	32	91.0	10	165	10
25	6.6	24	16.1	30	20.0	32	100.0	10	165	10

S=stroke

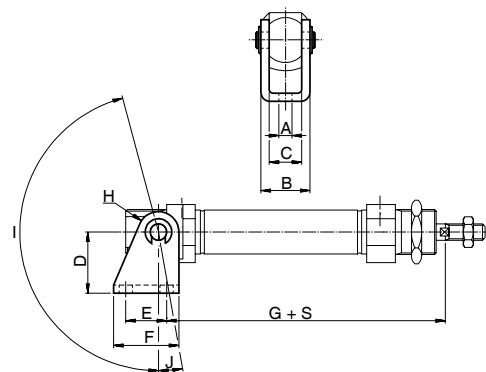

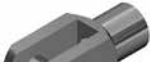
 Clevis AP2	According to ISO 8140 Intended for articulated mounting of the cylinder. This mounting is adjustable in the axial direction. Supplied complete with pin. Material: Galvanized steel	10	0.007	P1A-4CRC P1A-4DRC P1A-4HRC P1A-4JRC
		12-16	0.022	
		20	0.045	
		25	0.095	
 Stainless Clevis AP2	According to ISO 8140 Intended for articulated mounting of the cylinder. This mounting is adjustable in the axial direction. Supplied complete with pin. Material: Stainless steel, DIN X 5 CrNi 18 10	10	0.007	P1S-4CRD P1S-4DRD P1S-4HRD P1S-4JRD
		12-16	0.022	
		20	0.045	
		25	0.095	

Cylinder Ø mm	A mm	B	C mm	D mm	E mm	F mm	G mm	H mm	I mm	J mm
10	4	M4	2.2	8	8	5	16	4	22.0	2.0
12-16	6	M6	3.2	12	12	7	24	6	31.0	3.0
20	8	M8	4.0	16	16	10	32	8	40.5	3.5
25	10	M10x1.25	5.0	20	20	12	40	10	49.0	3.0

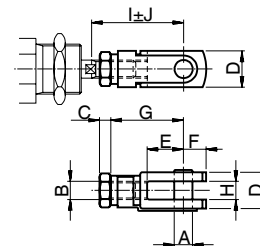

Cylinder mountings

Type	Description	Cyl. bore Ø mm	Weight kg	Order code
Swivel rod eye AP6	According to ISO 8139 Intended for articulated mounting of the cylinder. This mounting is adjustable in the axial direction. Material: Swivel rod eye: Galvanized steel Ball: hardened steel	10	0.017	P1A-4CRS P1A-4DRS P1A-4HRS P1A-4JRS
		12-16	0.025	
		20	0.045	
		25	0.085	



Stainless Swivel rod eye AP6	According to ISO 8139 Intended for articulated mounting of the cylinder. This mounting is adjustable in the axial direction. Material: Swivel rod eye: stainless steel, DIN X 5 CrNi 18 10 Ball: hardened stainless steel, DIN X 5 CrNi 18 10	10	0.017	P1S-4CRT P1S-4DRT P1S-4HRT P1S-4JRT
		12-16	0.025	
		20	0.045	
		25	0.085	



Cylinder Ø mm	A mm	B	C	D	E	F	G	H	I	J	K	L
10	5	M4	2,2	8	10	9	27	6,0	8	33,0	9	2,0
12-16	6	M6	3,2	9	10	10	30	6,8	9	38,5	11	1,5
20	8	M8	4,0	12	12	12	36	9,0	12	46,0	14	2,0
25	10	M10x1,25	5,0	14	14	14	43	10,5	15	52,5	17	2,5

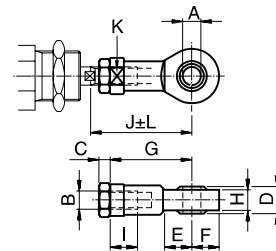

Stainless Rod nut MR9	Intended for fixed mounting on the piston rod. Cylinders are supplied complete with one rod nut. (cylinders with through piston rod are supplied with two rod nuts.) Material: Stainless steel, DIN X 5 CrNi 18 10	10	0.001	9127385121 9127385122 9127385123 9126725404
		12-16	0.002	
		20	0.005	
		25	0.007	



Cylinder Ø mm	D	F	E
10	M4	7	2.2
12-16	M6	10	3.2
20	M8	13	4.0
25	M10x1.25	17	5.0

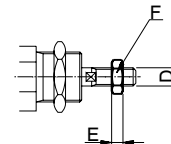

Our global series of sensors

This series of sensors is already being used or will be used in all future ranges in our global product programme involving cylinders/actuators. The sensors have small installation dimensions and either fit into the groove in the case profile or, as shown here, are fastened to the cylinder using a special attachment. You can choose from electronic or reed sensors with a range of cable lengths fitted with 8 mm or M12 terminals.



Electronic sensors

The new electronic sensors are "Solid State", i. e. they have no moving parts at all. They are provided with short-circuit protection and transient protection as standard. The built-in electronics make the sensors suitable for applications with high on and off switching frequency, and where very long service life is required.

Technical data

Design	GMR (Giant Magnetic Resistance) magneto-resistive function
Installation	Sensor mounting P8S-TMC01
Outputs	PNP, normally open (also available in NPN design, normally closed, on request)
Voltage range	10-30 VDC 10-18 V DC, ATEX sensor
Ripple	max 10%
Voltage drop	max 2,5 V
Load current	max 100 mA
Internal consumption	max 10 mA
Actuating distance	min 9 mm
Hysteresis	max 1,5 mm
Repeatability accuracy	max 0,2 mm
On/off switching frequency	max 5 kHz
On switching time	max 2 ms
Off switching time	max 2 ms
Encapsulation	IP 67 (EN 60529)
Temperature range	-25 °C to +75 °C -20 °C to +45 °C, ATEX sensor
Indication	LED, yellow
Material housing	PA 12
Material screw	Stainless steel
Cable	PVC or PUR 3x0.25 mm ² see order code respectively

Reed sensors

The sensors are based on proven reed switches, which offer reliable function in many applications. Simple installation, a protected position on the cylinder and clear LED indication are important advantages of this range of sensors.

Technical data

Design	Reed element
Mounting	Sensor mounting P8S-TMC01
Output	Normally open , or normally closed
Voltage range	10-30 V AC/DC or 10-120 V AC/DC 24-230 V AC/DC
Load current	max 500 mA for 10-30 V or max 100 mA for 10-120 V max 30 mA for 24-230 V
Breaking power (resistive)	max 6 W/VA
Actuating distance	min 9 mm
Hysteresis	max 1,5 mm
Repeatability accuracy	0.2 mm
On/off switching frequency	max 400 Hz
On switching time	max 1,5 ms
Off switching time	max 0,5 ms
Encapsulation	IP 67 (EN 60529)
Temperature range	-25 °C to +75 °C
Indication	LED, yellow
Material housing	PA12
Material screw	Stainless steel
Cable	PVC or PUR 3x0.14 mm ² see order code respectively

Electronic sensors

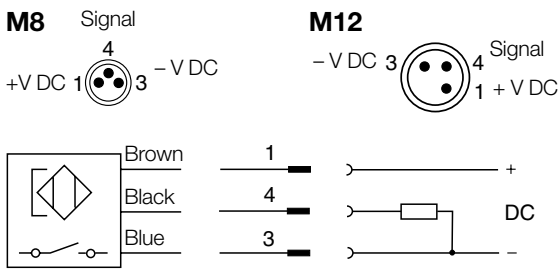

Reed sensors

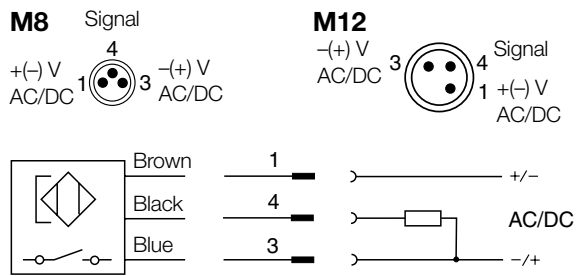

P8S-GCFPX

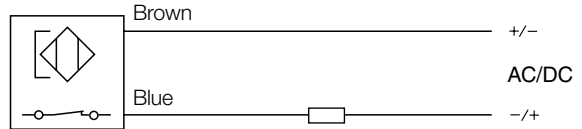

P8S-GRFLX / P8S-GRFLX2

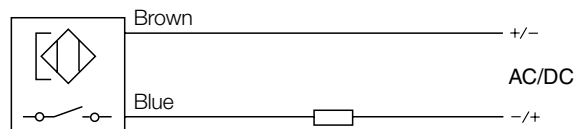

Dimensions

Sensors

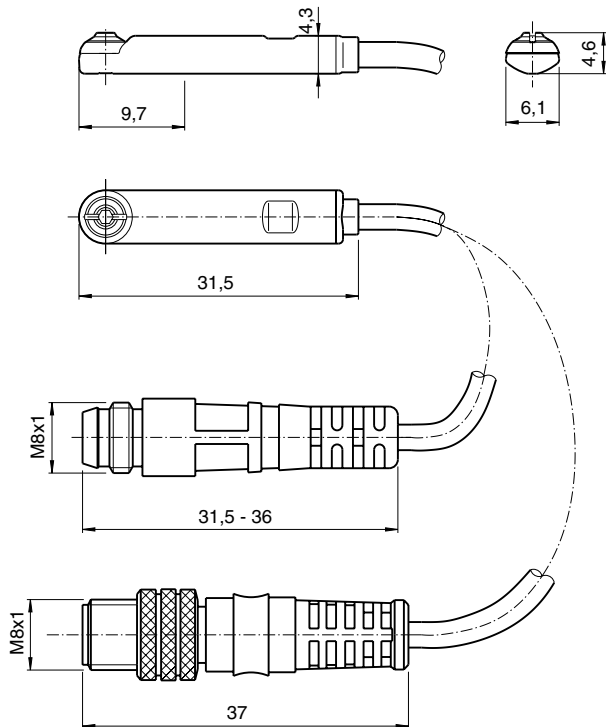

Sensor mounting P8S-TMC01

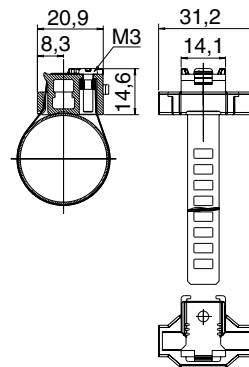

Ordering data

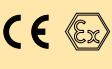
Output/function	Cable/connector	Weight kg	Order code
Electronic sensors , 10-30 V DC			
PNP type, normally open	0.27 m PUR-cable and 8 mm snap-in male connector	0.007	P8S-GPSHX
PNP type, normally open	1.0 m PUR-cable and 8 mm snap-in male connector	0.013	P8S-GPSCX
PNP type, normally open	1.0 m PUR-cable and M8 screw male connector	0.013	P8S-GPCCX
PNP type, normally open	0.27 m PUR-cable and M12 screw male connector	0.015	P8S-GPMHX
PNP type, normally open	3 m PVC-cable without connector	0.030	P8S-GPFLX
PNP type, normally open	10 m PVC-cable without connector	0.110	P8S-GPFTX
Electronic sensor 18-30 V DC			
ATEX-certified			
 II3G EEx nA II T4X II3D 135 °C IP67			
Type PNP , normally open	3 m PVC-cable without connector	0.030	P8S-GPFLX/EX
Reed sensors , 10-30 V AC/DC			
Normally open	0.27 m PUR-cable and 8 mm snap-in male connector	0.007	P8S-GSSHX
Normally open	1.0 m PUR-cable and 8 mm snap-in male connector	0.013	P8S-GSSCX
Normally open	1.0 m PUR-cable and M8 male connector	0.013	P8S-GSCCX
Normally open	0.27 m PUR-cable and M12 screw male connector	0.015	P8S-GSMHX
Normally open	1.0 m PUR-cable and M12 screw male connector	0.023	P8S-GSMCX
Normally open	3 m PVC-cable without connector	0.030	P8S-GSFLX
Normally open	10 m PVC-cable without connector	0.110	P8S-GSFTX
Normally closed	5m PVC-cable without connector ¹⁾	0.050	P8S-GCFPX
Reed sensors. 10-120 V AC/DC			
Normally open	3 m PVC-cable without connector	0.030	P8S-GRFLX
Reed sensorer, 24-230 V AC/DC			
Normally open	3 m PVC-cable without connector	0.030	P8S-GRFLX2

1) Without LED

Sensor mounting

Description	Weight kg	Order code
Sensor mounting for cylinder P1A cylinder bore Ø10 to Ø25 mm	0.07	P8S-TMC01

Connecting cables with one connector

The cables have an integral snap-in female connector.



Type of cable	Cable/connector	Weight kg	Order code
Cables for sensors, complete with one female connector			
Cable, Flex PVC	3 m, 8 mm Snap-in connector	0.07	9126344341
Cable, Flex PVC	10 m, 8 mm Snap-in connector	0.21	9126344342
Cable, Super Flex PVC	3 m, 8 mm Snap-in connector	0.07	9126344343
Cable, Super Flex PVC	10 m, 8 mm Snap-in connector	0.21	9126344344
Cable, Polyurethane	3 m, 8 mm Snap-in connector	0.01	9126344345
Cable, Polyurethane	10 m, 8 mm Snap-in connector	0.20	9126344346
Cable, Polyurethane	5 m, M12 screw connector	0.07	9126344348
Cable, Polyurethane	10 m, M12 screw connector	0.20	9126344349

Male connectors for connecting cables

Cable connectors for producing your own connecting cables. The connectors can be quickly attached to the cable without special tools. Only the outer sheath of the cable is removed. The connectors are available for M8 and M12 screw connectors and meet protection class IP 65.



Connector	Weight kg	Order code
M8 screw connector	0.017	P8CS0803J
M12 screw connector	0.022	P8CS1204J

Technical data

Operating voltage	max. 32 V AC/DC
Operating current per contact	max. 4 A
Connection cross section	0.25...0.5mm ² (conductor diameter min 0.1 mm)
Protection	IP65 and IP67 when plugged and screwed down (EN 60529)
Temperature range	-25...+85 °C

Parker Worldwide

Europe, Middle East, Africa

AE – United Arab Emirates, Dubai
Tel: +971 4 8127100
parker.me@parker.com

AT – Austria, Wiener Neustadt
Tel: +43 (0)2622 23501-0
parker.austria@parker.com

AT – Eastern Europe, Wiener Neustadt
Tel: +43 (0)2622 23501 900
parker.easteurope@parker.com

AZ – Azerbaijan, Baku
Tel: +994 50 2233 458
parker.azerbaijan@parker.com

BE/LU – Belgium, Nivelles
Tel: +32 (0)67 280 900
parker.belgium@parker.com

BG – Bulgaria, Sofia
Tel: +359 2 980 1344
parker.bulgaria@parker.com

BY – Belarus, Minsk
Tel: +48 (0)22 573 24 00
parker.poland@parker.com

CH – Switzerland, Etoy
Tel: +41 (0)21 821 87 00
parker.switzerland@parker.com

CZ – Czech Republic, Klecany
Tel: +420 284 083 111
parker.czechrepublic@parker.com

DE – Germany, Kaarst
Tel: +49 (0)2131 4016 0
parker.germany@parker.com

DK – Denmark, Ballerup
Tel: +45 43 56 04 00
parker.denmark@parker.com

ES – Spain, Madrid
Tel: +34 902 330 001
parker.spain@parker.com

FI – Finland, Vantaa
Tel: +358 (0)20 753 2500
parker.finland@parker.com

FR – France, Contamine s/Arve
Tel: +33 (0)4 50 25 80 25
parker.france@parker.com

GR – Greece, Athens
Tel: +30 210 933 6450
parker.greece@parker.com

HU – Hungary, Budaörs
Tel: +36 23 885 470
parker.hungary@parker.com

IE – Ireland, Dublin
Tel: +353 (0)1 466 6370
parker.ireland@parker.com

IL – Israel
Tel: +39 02 45 19 21
parker.israel@parker.com

IT – Italy, Corsico (MI)
Tel: +39 02 45 19 21
parker.italy@parker.com

KZ – Kazakhstan, Almaty
Tel: +7 7273 561 000
parker.easteurope@parker.com

NL – The Netherlands, Oldenzaal
Tel: +31 (0)541 585 000
parker.nl@parker.com

NO – Norway, Asker
Tel: +47 66 75 34 00
parker.norway@parker.com

PL – Poland, Warsaw
Tel: +48 (0)22 573 24 00
parker.poland@parker.com

PT – Portugal
Tel: +351 22 999 7360
parker.portugal@parker.com

RO – Romania, Bucharest
Tel: +40 21 252 1382
parker.romania@parker.com

RU – Russia, Moscow
Tel: +7 495 645-2156
parker.russia@parker.com

SE – Sweden, Spånga
Tel: +46 (0)8 59 79 50 00
parker.sweden@parker.com

SL – Slovenia, Novo Mesto
Tel: +386 7 337 6650
parker.slovenia@parker.com

TR – Turkey, Istanbul
Tel: +90 216 4997081
parker.turkey@parker.com

UA – Ukraine, Kiev
Tel: +48 (0)22 573 24 00
parker.poland@parker.com

UK – United Kingdom, Warwick
Tel: +44 (0)1926 317 878
parker.uk@parker.com

ZA – South Africa, Kempton Park
Tel: +27 (0)11 961 0700
parker.southafrica@parker.com

North America

CA – Canada, Milton, Ontario
Tel: +1 905 693 3000

US – USA, Cleveland
Tel: +1 216 896 3000

Asia Pacific

AU – Australia, Castle Hill
Tel: +61 (0)2-9634 7777

CN – China, Shanghai
Tel: +86 21 2899 5000

HK – Hong Kong
Tel: +852 2428 8008

IN – India, Mumbai
Tel: +91 22 6513 7081-85

JP – Japan, Tokyo
Tel: +81 (0)3 6408 3901

KR – South Korea, Seoul
Tel: +82 2 559 0400

MY – Malaysia, Shah Alam
Tel: +60 3 7849 0800

NZ – New Zealand, Mt Wellington
Tel: +64 9 574 1744

SG – Singapore
Tel: +65 6887 6300

TH – Thailand, Bangkok
Tel: +662 186 7000

TW – Taiwan, Taipei
Tel: +886 2 2298 8987

South America

AR – Argentina, Buenos Aires
Tel: +54 3327 44 4129

BR – Brazil, Sao Jose dos Campos
Tel: +55 800 727 5374

CL – Chile, Santiago
Tel: +56 2 623 1216

MX – Mexico, Toluca
Tel: +52 72 2275 4200

European Product Information Centre

Free phone: 00 800 27 27 5374

(from AT, BE, CH, CZ, DE, DK, EE, ES, FI, FR, IE, IL, IS, IT, LU, MT, NL, NO, PL, PT, RU, SE, SK, UK, ZA)

Parker Hannifin Ltd.

Tachbrook Park Drive
Tachbrook Park, Warwick CV34 6TU
United Kingdom
Tel.: +44 (0) 1926 317 878
Fax: +44 (0) 1926 317 855
parker.uk@parker.com
www.parker.com

