



aerospace
climate control
electromechanical
filtration
fluid & gas handling
hydraulics
pneumatics
process control
sealing & shielding



Global ISO Valves ISOMAX / ISYS

A complete range of pneumatic ISO valves

Industrial Communication

Catalogue PDE2589TCUK March 2014



ENGINEERING YOUR SUCCESS.



Important !

Before carrying out any service work, ensure that the valve and manifold have been vented. Remove the primary supply air hose to ensure total disconnection of the air supply before dismantling valves or blank connection blocks.



NB !

All technical data in this catalogue is typical only. The air quality is decisive for the valve life: see ISO 8573.



WARNING

FAILURE OR IMPROPER SELECTION OR IMPROPER USE OF THE PRODUCTS AND/OR SYSTEMS DESCRIBED HEREIN OR RELATED ITEMS CAN CAUSE DEATH, PERSONAL INJURY AND PROPERTY DAMAGE.

This document and other information from Parker Hannifin Corporation, its subsidiaries and authorized distributors provide product and/or system options for further investigation by users having technical expertise. It is important that you analyze all aspects of your application and review the information concerning the product or system in the current product catalog. Due to the variety of operating conditions and applications for these products or systems, the user, through its own analysis and testing, is solely responsible for making the final selection of the products and systems and assuring that all performance, safety and warning requirements of the application are met. The products described herein, including without limitation, product features, specifications, designs, availability and pricing, are subject to change by Parker Hannifin Corporation and its subsidiaries at any time without notice.

SALE CONDITIONS

The items described in this document are available for sale by Parker Hannifin Corporation, its subsidiaries or its authorized distributors. Any sale contract entered into by Parker will be governed by the provisions stated in Parker's standard terms and conditions of sale (copy available upon request).

ISO specification.....	4 - 5
Selecting guide.....	6 - 7
ISOMAX 15407-1 & 5599-1	
Highlight	8 - 9
Technical Characteristics	10 - 11
Order Key	12 - 17
Solenoid Operators	18 - 21
Isys ISO Individual Connection 15407-1 & 5599-1	
Highlight	22 - 23
Technical Characteristics	24 - 25
Order Key	26 - 31
Subbase, Manifolds,	32 - 35
Isys ISO Plug-in 15407-2 & 5599-2	
ISO 15407-2 Sizes 02 (18 mm) & 01 (26 mm)	
End plate kits	36 - 37
Manifold kits	38 - 39
Valves	40 - 41
ISO 5599-2 Sizes 1 to 3	
End plate kits	42 - 43
Manifold kits	44 - 45
Valves	46 - 47
Sandwich Modules	48 - 49
Industrial Communication	
TURCK BL67	
Highlight	52 - 54
Order Key	55 - 57
Isysnet	
Highlight	58 - 60
Order Key	61
Moduflex Bus	
Highlight	62
Order Key	63
Dimensions	64 - 77
Interconnect Circuit Boards	78

ISO Specifications

Individual connection

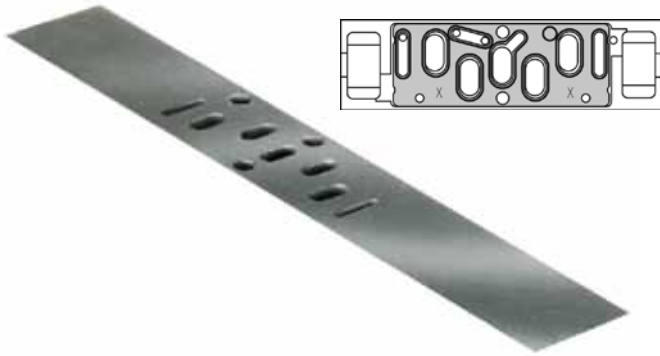

15407-1 (VDMA 24563)  ISO 15407-1

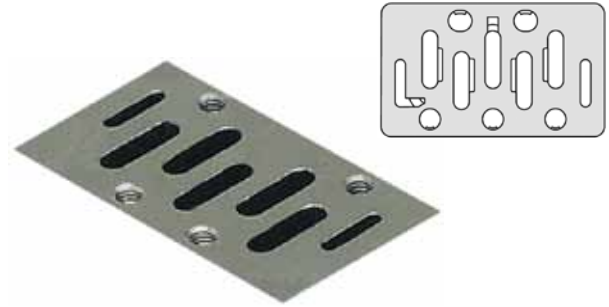

5599-1  ISO 5599-1

External electrical connection subbase valves

The ISO Standard 15407-1 specifies an interface pattern for a common subbase valve consisting of pressure passages 1, 3, 5, 2 & 4 and pilot passages 12 & 14. The width of the pattern and location of the 4 bolt holes are also specified. There are no specifications for the type of external electrical connection used to control the valve.

Size : 02 01

External electrical connection subbase valves

The ISO Standard 5599-1 specifies an interface pattern for a common subbase valve consisting of pressure passages 1, 3, 5, 2 & 4 and pilot passages 12 & 14. The width of the pattern and location of the 4 bolt holes are also specified. There are no specifications for the type of external electrical connection used to control the valve.

Size : 1 2 3

Plug-in connection

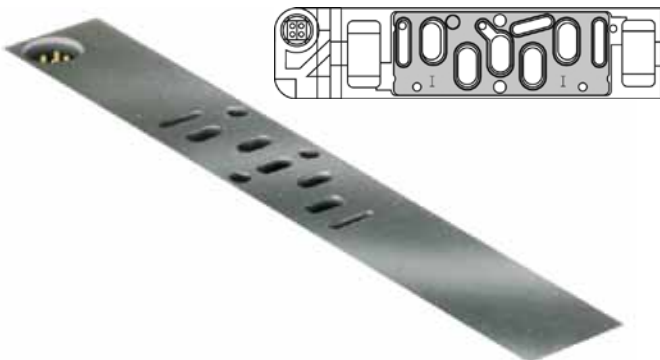

15407-2  ISO 15407-2



5599-2  ISO 5599-2

Body-to-base plug-in subbase valves

Same as 15407-1 for pneumatic pressure passages, 15407-2 standard also specifies a plug-in electrical connection.

Size : 01 02

- Pin 1 = 14 solenoid
- Pin 2 = 12 solenoid
- Pin 3 = Ground +
- Pin 4 = Common -

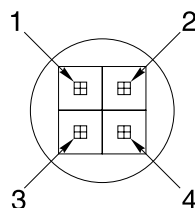

Body-to-base plug-in subbase valves

Same as 5599-1 for pneumatic pressure passages, 5599-2 standard also specifies a plug-in electrical connection.

Sizes : 1 2 3

- 1 = 12 solenoid
- 2 = 14 solenoid
- 3 = 12 solenoid
- 4 = 14 solenoid
- 5 = Ground

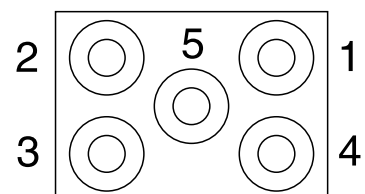

CNOMO and VDMA Standards

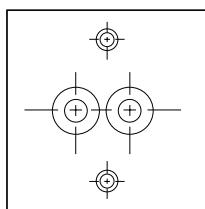

CNOMO 06-05-01

The solenoid pilot interface often used with ISO 5599-1 valves is the CNOMO interface. The CNOMO interface specifies the pressure and actuator port, and the screw holes for the mounting of this solenoid pilot. It is commonly used in European automotive plants, and its usage is becoming more prevalent for industrial ISO 5599-1 valves.

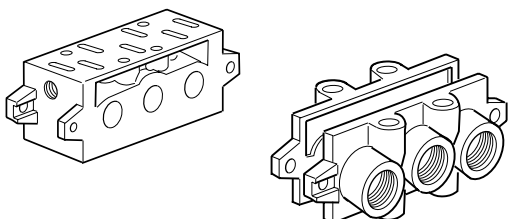

VDMA 24345

The VDMA 24345 is a standard for Manifolds and Subbase specifying a common base mounting footprint in addition to ISO 5599-1 Interface standard. (VDMA is a German organisation - Verband Deutscher Maschinen und Anlagen-Bauer - which is translated to Federation of German Machine and Unit Builders.)

Choice of components for air supply to cylinders

In the chart below can you find the suitable valves, tubes etc. for each cylinder size. If you have a tube length over 2 m, choose one tube size larger than in the chart.

Following data is valid:
 Supply pressure: min 7,0 bar
 Regulator pressure setting: 6,0 bar
 Pipe length between air treatment unit and valve: max 1 m
 Pipe length between valve and cylinder : max 2 m

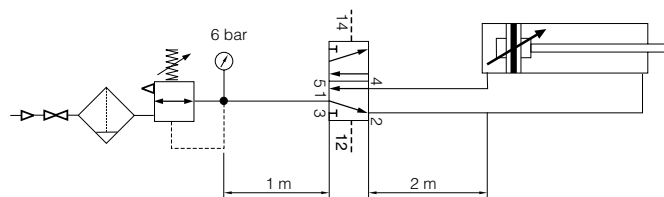





Cylinder bore	<Ø20	Ø20-32	Ø40-50	Ø63	Ø80	Ø100	Ø125	Ø160	Ø200
Cylinder port	M5	G1/8	G1/4	G3/8	G3/8	G1/2	G1/2	G3/4	G3/4
Tubing Ext / Int	4 / 2.7	6 / 4	8 / 6	10 / 7	10 / 7 12 / 9	12 / 9 14 / 11	14 / 11	18 / 15	20 / 18
Size 02 ISOMAX	G1/8	G1/8	G1/8	G1/8					
Isys	G1/8	G1/8	G1/8	G1/8	G1/8				
Size 01 ISOMAX	G1/4	G1/4	G1/4	G1/4	G1/4				
Isys	G1/4	G1/4	G1/4	G1/4	G1/4	G1/4			
Size 1 ISOMAX	G1/4	G1/4	G1/4	G1/4	G1/4	G1/4			
Isys	G1/4	G1/4	G1/4	G1/4	G1/4	G1/4	G1/4		
Isys			G3/8	G3/8	G3/8	G3/8	G3/8		
Size 2 ISOMAX			G3/8	G3/8	G3/8	G3/8	G3/8		
Isys			G3/8	G3/8	G3/8	G3/8	G3/8		
Isys				G1/2	G1/2	G1/2	G1/2	G1/2	G1/2
Size 3 ISOMAX				G1/2	G1/2	G1/2	G1/2	G1/2	G1/2
Isys				G1/2	G1/2	G1/2	G1/2	G1/2	G1/2
Isys						G3/4	G3/4	G3/4	G3/4



Cylinder speed < 0.5 m/s
 Cylinder speed < 1 m/s
 Cylinder speed > 1 m/s

ISO 15407 -1 / -2

Size 02 (18 mm) / 01 (26 mm)

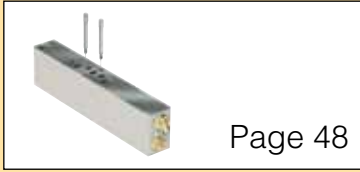
Cylinders from 10 to 100 mm bore

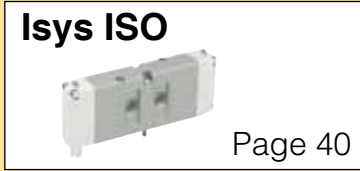





ISO 15407-1	Individual Connection	DIN C 15mm Solenoid	 <p>ISOMAX Page 12</p>	
		M12 Connector	 <p>Isys ISO Page 26</p>	
		Pneumatic Remote Pilot	 <p>ISOMAX Page 12</p>	 <p>Isys ISO Page 26</p>
		Subbase, Manifolds	 <p>Page 32</p>	
		Flow Control, Regulator	 <p>Page 48</p>	



ISO 15407-2	Plug-in	Plug-in	 <p>Isys ISO Page 40</p>	
		Subbase, Manifolds	 <p>Isys ISO Page 36</p>	
		Flow Control, Regulator	 <p>Isys ISO Page 48</p>	

ISO 5599 -1 / -2

Size 1 / 2 / 3

For Cylinders from 63 to 200 mm bore

ISO 5599-1	Individual Connection	DIN A, Industrial	ISOMAX  Page 14	Isys ISO  Page 28
		M12		Isys ISO  Page 30
		Remote pilot	ISOMAX  Page 14	Isys ISO  Page 30
		Subbase, Manifolds	 Page 32	
		Flow Control, Regulator	 Page 48	

ISO 5599-2	Plug-in	Plug-in	Isys ISO  Page 46
		Subbase, Manifolds	 Page 42
		Flow Control, Regulator	 Page 48

ISOMAX - General Applications

Market Application

- Automotive Handling
- Packaging
- Manufacturing
- General application



Ceramic technology

All ISOMAX products use high-tech ceramic switching technology :

- **Excellent reliability :**

Long life in excess of 100 million operations*.
Operates with lubricated or non lubricated air.
Low sensitivity to air quality changes ;
switching without seal.
Stiction free.

- **Size 02 & Size 01**

Solenoid exhaust pilot

- **High performances :**

Slide valve concept allows high flow / size ratio and short response time due to short slide stroke and low friction.

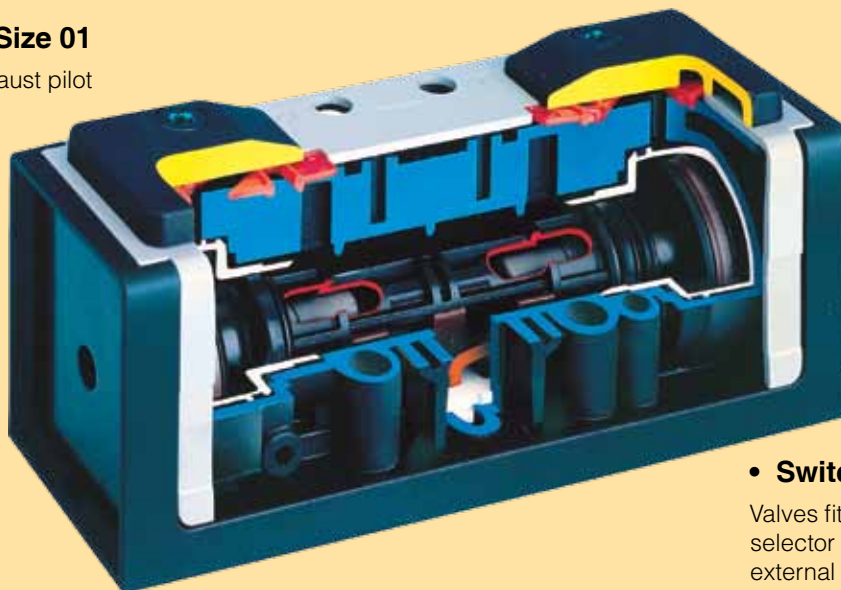

- **Switchable selector**

Valves fitted with switchable selector to give internal or external pilot supply

- **Stable long lasting performances**

Low friction switching : minimum wear of the valve member/seal assembly.

Ceramic plate

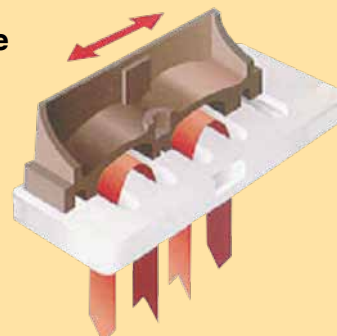

Rust and corrosion resistant body

With the valve body in polyamide reinforced fiberglass and the casting in anodised aluminium, the Isomax range presents a comprehensive modern design to suit most industrial environments.

Central M12 connection or M12 coil

All sizes of ISO 5599-1 are supplied with central M12 integrated connector, a M12 bridge cable or with a 30 x 30mm coil having M12 interface.

External supply selection

In order to use actuator with low pressure, it is possible to connect an external pressure on port 14 to supply both solenoids. Selection is easily made by reversing the gasket under the operator.

High reliability

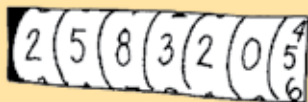

Valves easily comply with the requirements for the component reliability in accordance with EU Machinery Directive standards EN292-2 and EN983.

Maintenance

Spares are not required for the main valve or spool but solenoid operators can be replaced if required.

Manual Override

Solenoids are available with locking or non-locking manual overrides so that valves can be operated when the electrical supply is turned off.

Solenoid valves, CNOMO interface, 15mm solenoid



The standard valve is fitted with a 30mm solenoid having DIN 43650 Industrial form A connector for sizes 1, 2 and 3 15mm solenoid for sizes 01 and 02.

Low noise level

Size 01 and 02 valves fitted with the 15mm solenoid option use captured pilot exhaust which is channelled through the valve body and exhausts to atmosphere through channel 12

High electrical encapsulation class



The solenoid valves are protected to IP65 with the standard cable plug. Available with DIN A or M12 connection.

Wide choice of solenoid connectors/cable plugs



Solenoid connectors are available with or without LED and rectifier and may be selected fitted pre-wired with flying leads.

Valves having ATEX approval

ATEX approved options are available for use in explosive atmospheres. Consult our Technical Sales Department for further information.

Bottom or side ported manifold

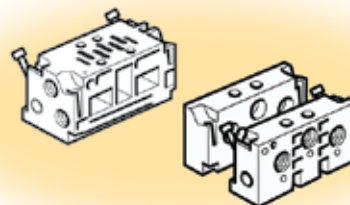

Manifolds with common ducts for ports 1,3 and 5, outlet port 2 and 4, and supply port for 12 and 14 are available side or bottom ported. Those manifolds are common for Isomax and Isys ISO.

Subbase installation VDMA

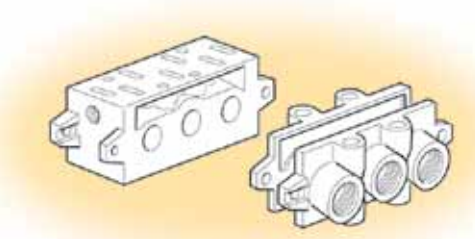

A large range of subbase, VDMA or not VDMA, bottom or side ported.

ISOMAX Flow Characteristics

Flow capacities in accordance with ISO6358, for 5/2 function. 5/3 function are around 10 to 20% less.

Technical Data ISOMAX Size 02

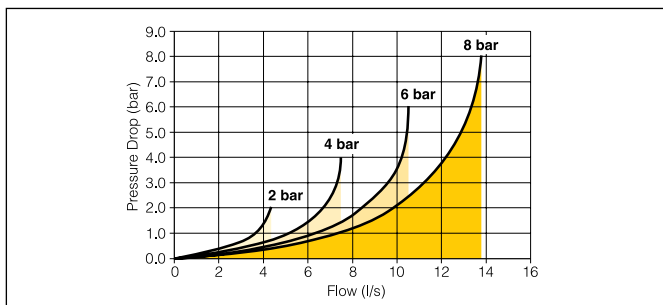

Operating pressure.	
5/2 Spring return	4,0 - 10 bar
5/2 Differential	3,0 - 10 bar
5/2 Double solenoid or pneumatic	2,0 - 10 bar
5/3 Double solenoid or pneumatic	4,0 - 10 bar
Working temperature.	
-10°C to + 60°C	
Flow (acc. to ISO 6358)	
c = 1,5 NI/s x bar	
b = 0,25	
Qn = 6,3 l/s	
Qmax = 10,6 l/s	

Technical Data ISOMAX Size 01

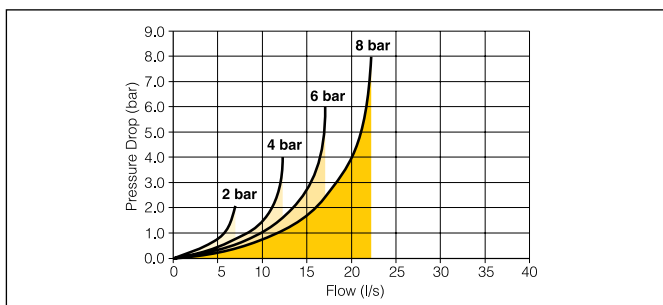

Operating pressure.	
5/2 Spring return	4,0 - 10 bar
5/2 Differential	3,0 - 10 bar
5/2 Double solenoid or pneumatic	2,0 - 10 bar
5/3 Double solenoid or pneumatic	4,0 - 10 bar
Working temperature.	
-10°C to + 60°C	
Flow (acc. to ISO 6358)	
c = 2,5 NI/s x bar	
b = 0,25	
Qn = 9,8 l/s	
Qmax = 17,1 l/s	

Technical Data ISOMAX Size 1

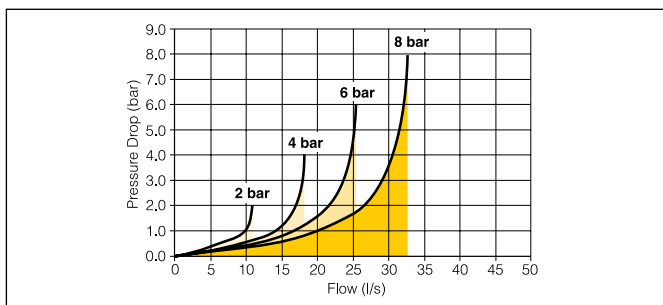

Operating pressure.	
5/2 Spring return	3,0 - 10 bar
5/2 Differential	2,0 - 10 bar
5/2 Double solenoid	1,0 - 10 bar
5/3 Double solenoid	3,5 - 10 bar
Pneumatic version	
12 bar	
Working temperature.	
-10°C to + 60°C	
Flow (acc. to ISO 6358)	
c = 3,8 NI/s x bar	
b = 0,35	
Qn = 17,2 l/s	
Qmax = 25,5 l/s	

Technical Data ISOMAX Size 2

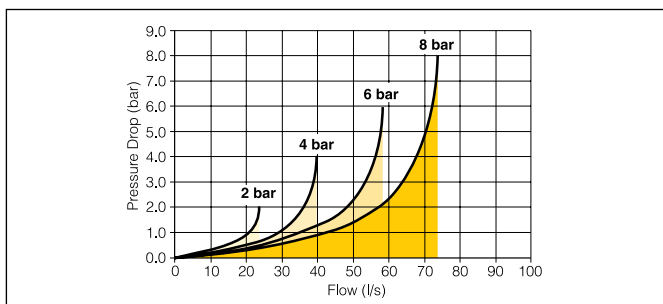

Operating pressure.	
5/2 Spring return	2,5 - 10 bar
5/2 Differential	2,0 - 10 bar
5/2 Double solenoid	1,0 - 10 bar
5/3 Double solenoid	3,0 - 10 bar
Pneumatic version	
12 bar	
Working temperature.	
-10°C to + 60°C	
Flow (acc. to ISO 6358)	
c = 8,2 NI/s x bar	
b = 0,35	
Qn = 38,3 l/s	
Qmax = 58,7 l/s	

Technical Data ISOMAX Size 3

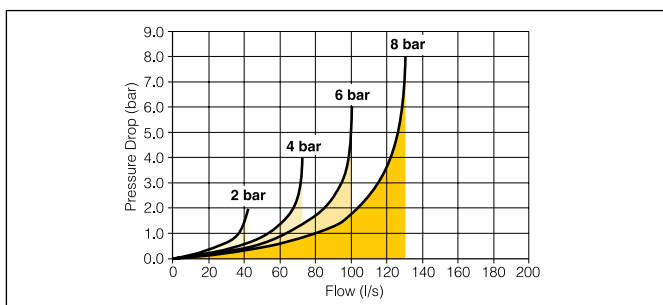

Operating pressure.	
5/2 Spring return	2,5 - 10 bar
5/2 Differential	2,0 - 10 bar
5/2 Double solenoid	1,0 - 10 bar
5/3 Double solenoid	3,0 - 10 bar
Pneumatic version	
12 bar	
Working temperature.	
-10°C to + 60°C	
Flow (acc. to ISO 6358)	
c = 14,5 NI/s x bar	
b = 0,35	
Qn = 64,0 l/s	
Qmax = 101,0 l/s	

ISOMAX Material Specification and Characteristics

Material Specification

Valve member - seat :	Self lubricating acetal - ceramic
Body :	Polyamide reinforced fibreglass
Casing - End plates :	Anodised aluminium - Painted zinc - Plated steel
Valve plate :	Zamak
Seals :	Nitrile
Springs :	Stainless steel
Screws :	Zinc plated steel
Top cover - Seal :	Polyamide reinforced fiberglass - Polyester

Technical Characteristics

Fluid :	Air or inert gas filtered 40u class 5 according to ISO 8573-1 Dry class 4 according to ISO 8573-1 non-lubricated, or lubricated
Storage temperature :	-20° to + 70°
Vibration :	2g - from 2 to 150 Hz according to IEC 68-2-6
Shock :	15g - 11ms according to IEC 68-2-7

Changeover time (ms) at 6 bar - Actua. / Return

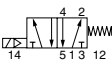
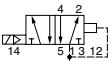
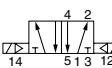
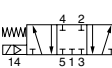
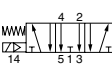
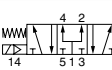
Valve Function	Solenoid Operated Valves					Pneumatic Operated Valves				
	02	01	1	2	3	02	01	1	2	3
	15/25	25/35	40/55	60/105	85/160	15/25	25/35	30/45	50/95	80/160
	15/30	20/40	30/70	55/110	80/180	15/30	20/40	25/60	45/100	70/170
	12/12	15/15	25/25	30/30	40/40	12/12	14/14	20/20	25/25	35/35
	20/60	20/60	30/95	40/190	55/330	20/50	20/50	20/80	30/170	45/330
	20/60	20/60	25/70	40/140	60/270	20/50	20/50	20/65	30/140	50/270
			25/65	40/150				20/60	25/140	

ISOMAX - ISO 15407-1 - Sizes 02 & 01
Pneumatic remote pilot or 15 mm DIN C solenoid valve operated

Order chart



**For Electro-Pneumatic pilot valve only
Solenoid valve operator definition**

DX 01 - 6 21 - 95 1 M S

Size	
02	Size 02 : 18 mm
01	Size 01 : 26 mm

Pilot	
4	Pneumatic
6	Electro-Pneumatic

Valve function	
06	5/2 double solenoid
56	5/2 double solenoid, 14 prioritised
21	5/2 single solenoid, spring return
51	5/2 single solenoid, differential return
11	5/3 double solenoid vented centre
16	5/3 double solenoid closed centre

Internal pilot supply / Capture exhaust 12	
06	5/2 double solenoid
56	5/2 double solenoid, 14 prioritised
21	5/2 single solenoid, spring return
51	5/2 single solenoid, differential return
11	5/3 double solenoid vented centre
16	5/3 double solenoid closed centre

External pilot 14 supply / Capture exhaust 12	
05	5/2 double solenoid
59	5/2 double solenoid, 14 prioritised
23	5/2 single solenoid, spring return
54	5/2 single solenoid, differential return
09	5/3 double solenoid vented centre
19	5/3 double solenoid closed centre

Connector	
Blank	Without any
C	Standard connector No cable
S	Connector with LED and protection - No cable
S3	Connector with LED and protection - 3 m cable
S5	Connector with LED and protection - 5 m cable

Voltage	
L	12 Vdc
M	24 Vdc
N	48 Vdc
C	24 Vac - 50 Hz
D	48 Vac - 50/60 Hz
J	110 Vac - 50/60 Hz
A	230 VAC - 50/60 Hz

Manual override	
0	Without any
1	Flush non locking
2	Flush non locking (extended 15 mm)
3	Flush locking
5	Flush locking (extended 15 mm)

Operator	
60	Remote pneumatic pilot operated

For pneumatic pilot valve	
60	Remote pneumatic pilot operated

For electro-pneumatic pilot valve	
60	Without 15 mm solenoid valve operator*
95	15 mm solenoid valve operator - DIN 43650 Form C

* 15 mm solenoid valve operator to be ordered separately

Shaded part numbers constituted with shaded voltage code are available from stock.
 Shaded part numbers constituted by unshaded voltage code are available on request but are subject to a minimum order quantity. Otherwise, select « Blank » as voltage code and order coil separately.

ISOMAX - ISO 15407-1 - Sizes 02 & 01

Pneumatic remote pilot operated

Without valve spool manual override

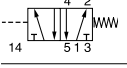
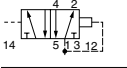
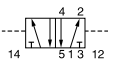
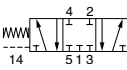
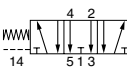
Symbol	Description	Size	Weight (g)	Order code	
		5/2 Air pilot - Spring return	02 - 18 mm	90	DX02-421-60
			01 - 26mm	130	DX01-421-60
		5/2 Air pilot - Differential	02 - 18 mm	90	DX02-451-60
			01 - 26mm	130	DX01-451-60
		5/2 Double air pilot	02 - 18 mm	90	DX02-406-60
			01 - 26mm	130	DX01-406-60
		5/3 Closed Centre	02 - 18 mm	90	DX02-416-60
			01 - 26mm	130	DX01-416-60
		5/3 Vented Center	02 - 18 mm	90	DX02-411-60
			01 - 26mm	130	DX01-411-60

ISOMAX - ISO 15407-1 - Sizes 02 & 01

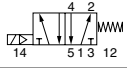
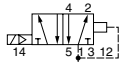
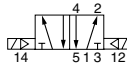
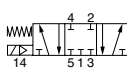
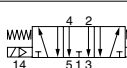

15 mm DIN C / 24 Vdc / 1,2 W solenoid valve operator

Symbol	Description	Size	Weight (g)	Order code	
		5/2 Single solenoid - Spring return	02 - 18 mm	130	DX02-621-951M
			01 - 26mm	170	DX01-621-951M
		5/2 Single solenoid - Differential	02 - 18 mm	130	DX02-651-951M
			01 - 26mm	170	DX01-651-951M
		5/2 Double solenoid	02 - 18 mm	130	DX02-606-951M
			01 - 26mm	170	DX01-606-951M
		5/3 Closed Centre	02 - 18 mm	130	DX02-616-951M
			01 - 26mm	170	DX01-616-951M
		5/3 Vented Center	02 - 18 mm	160	DX02-611-951M
			01 - 26mm	170	DX01-611-951M

Solenoid connectors & cable plugs to be ordered separately. See solenoid section

ISOMAX - ISO 15407-1 - Sizes 02 & 01

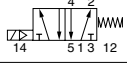
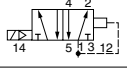
Without 15 mm DIN C solenoid valve operator

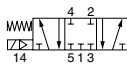
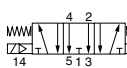
Symbol	Description	Size	Weight (g)	Order code	
		5/2 Single solenoid - Spring return	02 - 18 mm	130	DX02-621-60
			01 - 26mm	170	DX01-621-60
		5/2 Single solenoid - Differential	02 - 18 mm	130	DX02-651-60
			01 - 26mm	170	DX01-651-60
		5/2 Double solenoid	02 - 18 mm	130	DX02-606-60
			01 - 26mm	170	DX01-606-60
		5/3 Closed Centre	02 - 18 mm	130	DX02-616-60
			01 - 26mm	170	DX01-616-60
		5/3 Vented Center	02 - 18 mm	160	DX02-611-60
			01 - 26mm	170	DX01-611-60

15mm solenoid valve operator, solenoid connectors & cable plug to be ordered separately. See solenoid section

ISOMAX - ISO 5599-1 - Sizes 1, 2 & 3

Pneumatic remote pilot or CNOMO operator - DIN or M12 connection

Order chart



**For Electro-Pneumatic pilot valve only
Solenoid valve operator definition**

DX 1 - 6 51 - B L 49

Size	
1	Size 1
2	Size 2
3	Size 3

Pilot	
4	Pneumatic
6	Electro-Pneumatic

Valve function	
----------------	--

Internal pilot supply	
06	5/2 double solenoid
56	5/2 double solenoid, 14 prioritised
21	5/2 single solenoid, spring return
51	5/2 single solenoid, differential return
11	5/3 double solenoid vented centre
13	5/3 double solenoid pressurised center
16	5/3 double solenoid closed centre

External pilot 14 supply / Capture exhaust 12	
05	5/2 double solenoid
59	5/2 double solenoid, 14 prioritised
23	5/2 single solenoid, spring return
54	5/2 single solenoid, differential return
09	5/3 double solenoid vented centre
14	5/3 double solenoid pressurised center
19	5/3 double solenoid closed centre

Voltage	
---------	--

Blank	Operator only (without coil)
-------	------------------------------

M12 connection	
----------------	--

19	24 Vdc
----	--------

DIN connector	
---------------	--

45	12 Vdc
49	24 Vdc
40	12 Vac - 50/60 Hz
42	24 Vac - 50/60 Hz
53	110 Vac - 50Hz / 120 Vac - 60Hz
57	230 Vac - 50/60 Hz

Solenoid enclosure	
--------------------	--

CNOMO 30 x 30 Operator for Low Power Coil	
---	--

L	Operator with coil
N	Operator only without coil

M12 connector	
---------------	--

2	One connector per distributor
6	One built-in connector per coil

Manual override	
-----------------	--

On Pneumatic Valves or Electric Valves without operator	
---	--

60	Without direct spool override
70	With direct spool override

On electric operator *	
------------------------	--

A	Without any
B	Non locking - Flush - Metal
C	Locking - Flush - Plastic

* Without direct valve spool manual override

Shaded part numbers constituted with shaded voltage code are available from stock.
 Shaded part numbers constituted by unshaded voltage code are available on request but are subject to a minimum order quantity. Otherwise, select « Blank » as voltage code and order coil separately.

ISOMAX - ISO 5599-1 - Sizes 1, 2 & 3 Pneumatic remote pilot operated

With direct valve spool manual override

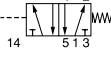
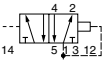
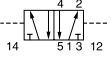
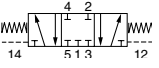
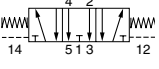
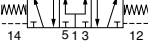
Symbol	Description	Size	Weight (g)	Order code
 	5/2 Air pilot - Spring return	1 - 43 mm	350	DX1-421-70
		2 - 56 mm	600	DX2-421-70
		3 - 71 mm	1100	DX3-421-70
	5/2 Air pilot - Differential	1 - 43 mm	350	DX1-451-70
		2 - 56 mm	600	DX2-451-70
		3 - 71 mm	1100	DX3-451-70
	5/2 Double air pilot	1 - 43 mm	350	DX1-406-70
		2 - 56 mm	600	DX2-406-70
		3 - 71 mm	1100	DX3-406-70
	5/3 Closed Center	1 - 43 mm	350	DX1-416-70
		2 - 56 mm	600	DX2-416-70
		3 - 71 mm	1100	DX3-416-70
	5/3 Vented Center	1 - 43 mm	350	DX1-411-70
		2 - 56 mm	600	DX2-411-70
		3 - 71 mm	1100	DX3-411-70
	5/3 Pressurised Center	1 - 43 mm	350	DX1-413-70
		2 - 56 mm	600	DX2-413-70



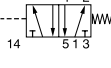
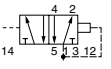
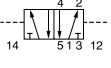
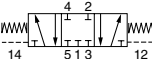
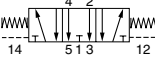
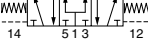

ISOMAX - ISO 5599-1 - Sizes 1, 2 & 3 Pneumatic remote pilot operated

Without direct valve spool manual override

Symbol	Description	Size	Weight (g)	Order code
 	5/2 Air pilot - Spring return	1 - 43 mm	350	DX1-421-60
		2 - 56 mm	600	DX2-421-60
		3 - 71 mm	1100	DX3-421-60
	5/2 Air pilot - Differential	1 - 43 mm	350	DX1-451-60
		2 - 56 mm	600	DX2-451-60
		3 - 71 mm	1100	DX3-451-60
	5/2 Double air pilot	1 - 43 mm	350	DX1-406-60
		2 - 56 mm	600	DX2-406-60
		3 - 71 mm	1100	DX3-406-60
	5/3 Closed Center	1 - 43 mm	350	DX1-416-60
		2 - 56 mm	600	DX2-416-60
		3 - 71 mm	1100	DX3-416-60
	5/3 Vented Center	1 - 43 mm	350	DX1-411-60
		2 - 56 mm	600	DX2-411-60
		3 - 71 mm	1100	DX3-411-60
	5/3 Pressurised Center	1 - 43 mm	350	DX1-413-60
		2 - 56 mm	600	DX2-413-60

ISOMAX - ISO 5599-1 - Sizes 1, 2 & 3 CNOMO operator with 30 x 30 DIN Form A / 24 Vdc / 2,7 W solenoid

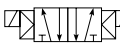
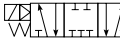





With non locking manual override on solenoid valve operator - Without direct valve spool manual override

Symbol	Description	Size	Weight (g)	Order code
	5/2 Single solenoid - Spring return 	1 - 43 mm	500	DX1-621-BL49
		2 - 56 mm	750	DX2-621-BL49
		3 - 71 mm	1250	DX3-621-BL49
	5/2 Single solenoid - Differential	1 - 43 mm	500	DX1-651-BL49
		2 - 56 mm	750	DX2-651-BL49
		3 - 71 mm	1250	DX3-651-BL49
	5/2 Double solenoid	1 - 43 mm	650	DX1-606-BL49
		2 - 56 mm	900	DX2-606-BL49
		3 - 71 mm	1400	DX3-606-BL49
	5/3 Closed Center	1 - 43 mm	560	DX1-616-BL49
		2 - 56 mm	900	DX2-616-BL49
		3 - 71 mm	1400	DX3-616-BL49
	5/3 Vented Center	1 - 43 mm	650	DX1-611-BL49
		2 - 56 mm	900	DX2-611-BL49
		3 - 71 mm	1400	DX3-611-BL49
	5/3 Pressurised Center	1 - 43 mm	650	DX1-613-BL49
		2 - 56 mm	900	DX2-613-BL49

Solenoid connectors & cable plug to be ordered separately. See solenoid section

ISOMAX - ISO 5599-1 - Sizes 1, 2 & 3 CNOMO operator without coil

With non locking manual override on solenoid valve operator - Without direct valve spool manual override

Symbol	Description	Size	Weight (g)	Order code
	5/2 Single solenoid - Spring return 	1 - 43 mm	400	DX1-621-BN
		2 - 56 mm	650	DX2-621-BN
		3 - 71 mm	1150	DX3-621-BN
	5/2 Single solenoid - Differential	1 - 43 mm	400	DX1-651-BN
		2 - 56 mm	650	DX2-651-BN
		3 - 71 mm	1150	DX3-651-BN
	5/2 Double solenoid	1 - 43 mm	550	DX1-606-BN
		2 - 56 mm	800	DX2-606-BN
		3 - 71 mm	1300	DX3-606-BN
	5/3 Closed Center	1 - 43 mm	550	DX1-616-BN
		2 - 56 mm	800	DX2-616-BN
		3 - 71 mm	1300	DX3-616-BN
	5/3 Vented Center	1 - 43 mm	550	DX1-611-BN
		2 - 56 mm	800	DX2-611-BN
		3 - 71 mm	1300	DX3-611-BN
	5/3 Pressurised Center	1 - 43 mm	550	DX1-613-BN
		2 - 56 mm	800	DX2-613-BN

30 x 30 DIN Form A or 22 x 30 DIN Form B coil & coil connectors to be ordered separately. See solenoid section

ISOMAX - ISO 5599-1 - Sizes 1, 2 & 3 Valve alone without operator

With direct valve spool manual override

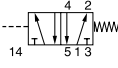
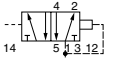
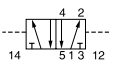
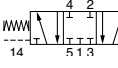
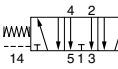
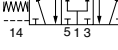
Symbol	Description	Size	Weight (g)	Order code
 	5/2 Single pilot - Spring return	1 - 43 mm	350	DX1-621-70
		2 - 56 mm	600	DX2-621-70
		3 - 71 mm	1100	DX3-621-70
	5/2 Single pilot - Differential	1 - 43 mm	350	DX1-651-70
		2 - 56 mm	600	DX2-651-70
		3 - 71 mm	1100	DX3-651-70
	5/2 Double pilot	1 - 43 mm	350	DX1-606-70
		2 - 56 mm	600	DX2-606-70
		3 - 71 mm	1100	DX3-606-70
	5/3 Closed Center	1 - 43 mm	350	DX1-616-70
		2 - 56 mm	600	DX2-616-70
		3 - 71 mm	1100	DX3-616-70
	5/3 Vented Center	1 - 43 mm	350	DX1-611-70
		2 - 56 mm	600	DX2-611-70
		3 - 71 mm	1100	DX3-611-70
	5/3 Pressurised Center	1 - 43 mm	350	DX1-613-70
		2 - 56 mm	600	DX2-613-70

ISOMAX - ISO 5599-1 - Sizes 1, 2 & 3 Valve alone without operator

Without direct valve spool manual override

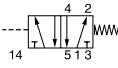
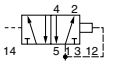
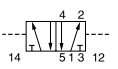
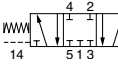
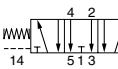
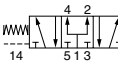
Symbol	Description	Size	Weight (g)	Order code
 	5/2 Single pilot - Spring return	1 - 43 mm	350	DX1-621-60
		2 - 56 mm	600	DX2-621-60
		3 - 71 mm	1100	DX3-621-60
	5/2 Single pilot - Differential	1 - 43 mm	350	DX1-651-60
		2 - 56 mm	600	DX2-651-60
		3 - 71 mm	1100	DX3-651-60
	5/2 Double pilot	1 - 43 mm	350	DX1-606-60
		2 - 56 mm	600	DX2-606-60
		3 - 71 mm	1100	DX3-606-60
	5/3 Closed Center	1 - 43 mm	350	DX1-616-60
		2 - 56 mm	600	DX2-616-60
		3 - 71 mm	1100	DX3-616-60
	5/3 Vented Center	1 - 43 mm	350	DX1-611-60
		2 - 56 mm	600	DX2-611-60
		3 - 71 mm	1100	DX3-611-60
	5/3 Pressurised Center	1 - 43 mm	350	DX1-613-60
		2 - 56 mm	600	DX2-613-60

15 mm N.C. Solenoid Operator - DIN Form C for ISOMAX 15407-1 Sizes 02 & 01

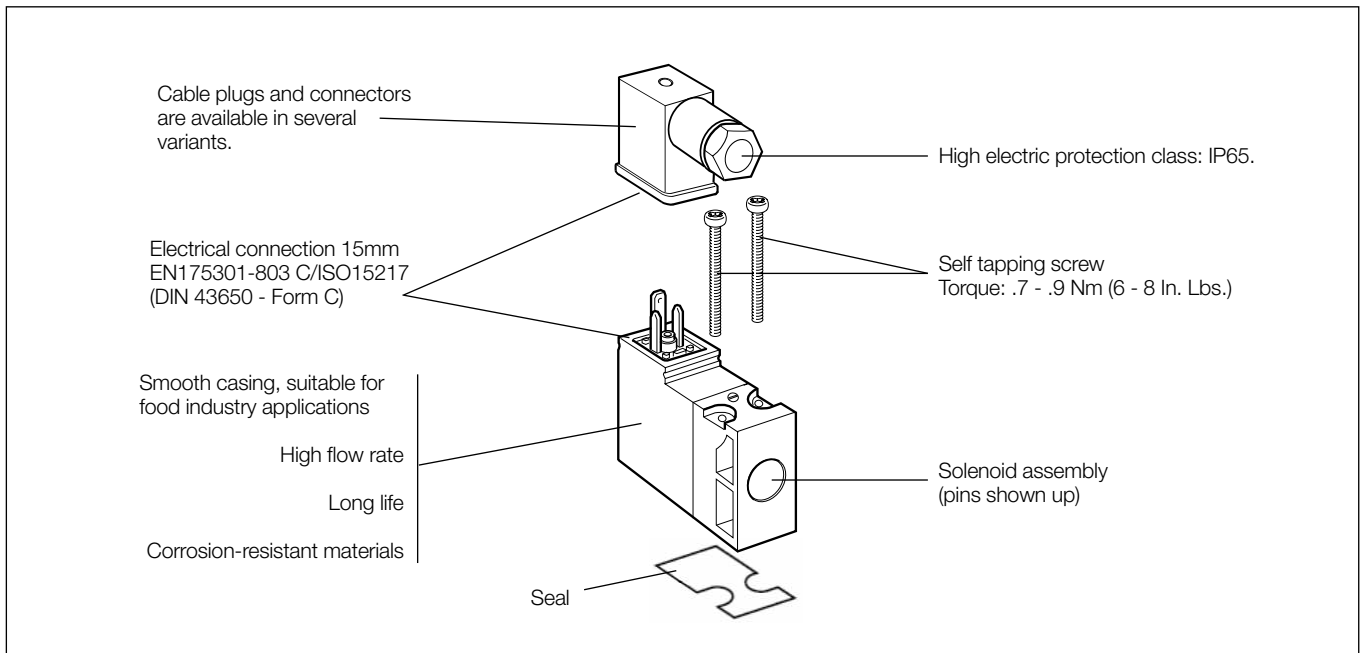

Technical data

	NC, Standard	NC, Food¹⁾	NC, Mobile²⁾
Working pressure	0 to 10 bar	0 to 10 bar	0 to 10 bar
Working temperature	-15 °C to +60 °C	-15 °C to +60 °C	-40 °C to +70 °C
Orifice	1,0 mm	1,0 mm	1,0 mm
Flow Qmax	33 Nl/min	33 Nl/min	22 Nl/min
Power, hold	DC 1,2 W / AC 1,6 VA *	DC 1,2 W / AC 1,6 VA *	DC 1,4 W
Power, surge	DC 1,2 W / AC 3,5 VA *	DC 1,2 W / AC 3,5 VA *	DC 1,4 W
Connection time	100%	100%	100%
Voltage tolerance	+10%/-15%	+10%/-15%	+25%/-30%
Electric connection:	Form C/ISO15217		
Port pattern:	To future CNOMO standard		
Protection:	IP 65		
Approval:	Some valves are UL 429 recognised and marked with the following symbol		
Working media:	All neutral media, such as compressed air, water, hydraulic oil and many gases.		
1) Design:	Completely smooth exterior, suitable for food industry.		
2) Mobile standard	According to European standard EN 50 155.		

* Power, hold for 230VAC 2.4VA
 Power, surge for 230VAC 5.5VA

Transients

Interrupting the current through the solenoid coil produces momentary voltage peaks which, under unfavourable conditions, can amount to several hundred times the rated operating voltage. Normally, these transients do not cause problems, but to achieve the maximum life of relays in the circuit (and particularly of transistors, thyristors and integrated circuits) it is desirable to provide protection by means of voltage-dependent resistors (varistors). All cable plugs with a yellow LED also incorporate such protection.

Service life

With compressed air at 6 bar, 20 °C and complying with the requirements for compressed air quality as set out in ISO8573-1 norm (class 4 for dry and class 5 for filtered air), the valves should have a life of at least 50 million cycles.

Materials







Operator

Body, coil casing	Thermoplastic
Internal metal parts	Steel
Screws	Stainless steel
Bottom plug	Thermoplastic
Sealing materials	FPM (Viton™) and nitrile rubber

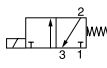
Cable head

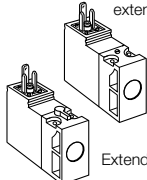
Sheath	Thermoplastic
Retaining screw	Stainless steel, zinc-plated steel

15 mm N.C. Solenoid Operator - Standard version

Voltage	W (g)	Order code	Not Extended			Extended	
			Without Manual Override	Blue Override non locking flush	Yellow Override Locking flush	Blue Override non locking flush	Yellow Override Locking flush
 Not extended	12 Vdc	38	 P2E-KV32B0	P2E-KV32B1	P2E-KV32B2		
	24 Vdc	38	 P2E-KV32C0	P2E-KV32C1	P2E-KV32C2	P2E-KV32C3	P2E-KV32C4
 Extended	48 Vdc	38	 P2E-KV32D0	P2E-KV32D1	P2E-KV32D2		
	24 Vac 50 Hz	38	 P2E-KV31C0	P2E-KV31C1	P2E-KV31C2	P2E-KV31C3	P2E-KV31C4
	48 Vac 50/60Hz	38	 P2E-KV34D0	P2E-KV34D1	P2E-KV34D2		
	115 Vac 50Hz/ 120 Vac 60Hz	38	 P2E-KV31F0	P2E-KV31F1	P2E-KV31F2		
	230 Vac 50Hz	38	P2E-KV31J0	P2E-KV31J1	P2E-KV31J2		
	240 Vac 60Hz/						





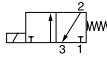

Mounting screws included with the solenoid valve operator

15 mm N.C. Solenoid Operator - Mobile version

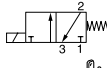
Voltage	W (g)	Order code	Without Manual Override	Not Extended Blue Override non locking flush
			Order code	Order code
 Not extended	12 Vdc	38	P2E-MV35B0	P2E-MV35B1
	24 Vdc	38	P2E-MV35C0	P2E-MV35C1
	37,5 Vdc	38	P2E-MV35W0	P2E-MV35W1
	48 Vdc	38	P2E-MV35D0	P2E-MV35D1
	72 Vdc	38	P2E-MV35T0	P2E-MV35T1
	78 Vdc	38	P2E-MV35Y0	P2E-MV35Y1
	96 Vdc	38	P2E-MV35V0	P2E-MV35V1
	110 Vdc	38	P2E-MV35E0	P2E-MV35E1

Mounting screws included with the solenoid valve operator

15 mm N.C. Solenoid Operator - Food Industry version

Voltage	W (g)	Order code	Not Extended			Extended	
			Without Manual Override	Blue Override non locking flush	Yellow Override Locking flush	Blue Override non locking flush	Yellow Override Locking flush
 Not extended	24 Vdc	38	 P2E-QV32C0	P2E-QV32C1	P2E-QV32C2	P2E-QV32C3	P2E-QV32C4
	48 Vdc	38	 P2E-QV32D0	P2E-QV32D1	P2E-QV32D2		
	24 Vac 50 Hz	38	 P2E-QV31C0	P2E-QV31C1	P2E-QV31C2	P2E-QV31C3	P2E-QV31C4
	48 Vac 50/60Hz	38	 P2E-QV34D0	P2E-QV34D1	P2E-QV34D2		
	115 Vac 50Hz/ 120 Vac 60Hz	38	 P2E-QV31F0	P2E-QV31F1	P2E-QV31F2	P2E-QV31F3	P2E-QV31F4
	230 Vac 50Hz	38	P2E-QV31J0	P2E-QV31J1	P2E-QV31J2	P2E-QV31J3	P2E-QV31J4
	240 Vac 60Hz/						

Mounting screws included with the solenoid valve operator

Solenoid Connectors 15 mm DIN Form C / ISO15217

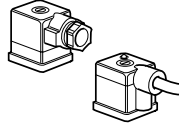
Description	Characteristic	Visualisation	Cable length	W (g)	Order code	
 With large headed screw suitable for mounting in inaccessible or recess position	Standard IP65	No LED	No cable	20	P8C-C	
			24 Vdc LED	No cable	20	P8C-C26C
			110 Vac LED	No cable	20	P8C-C21E
 With standard screw	Standard IP65	No LED	No cable	15	P8C-D	
			2 meters	115	P8L-C2	
			5 meters	240	P8L-C5	
			24 Vdc/Vac LED	No cable	15	P8C-D26C
				2 meters	170	P8L-C226C
				5 meters	240	P8L-C26C
			110 Vac LED	10 meters	440	P8L-CA26C
				No cable	115	P8C-D21E
				2 meters	115	P8L-C221E
			5 meters	230	P8L-C521E	

In accordance with the EU Machine Directive, EN 983, solenoid valves with manual override should have spring-return operating arms for safety.

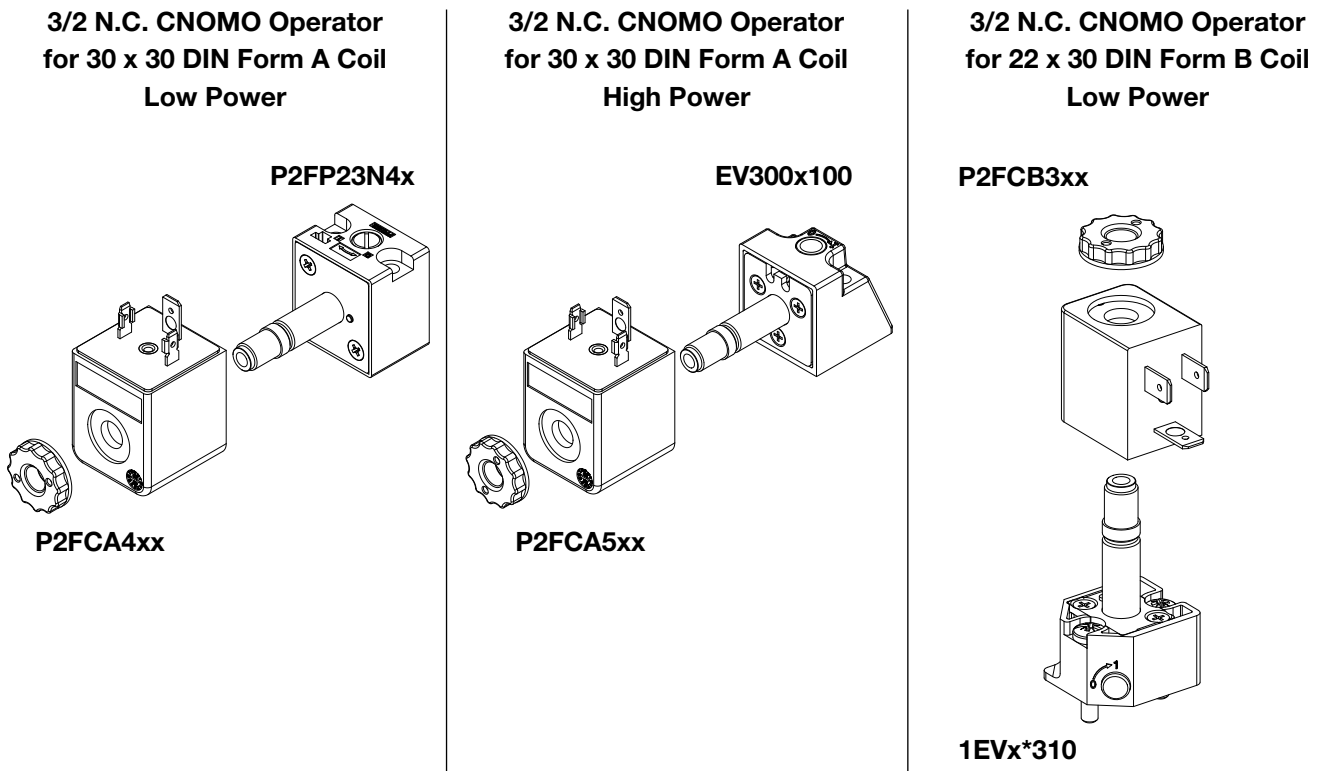

3/2 N.C. CNOMO Operator for 30 x 30 DIN Form A or 22 x 30 DIN Form B coils



Technical data - Solenoid operator & Coil combinations

		3/2 N.C. CNOMO Operators		
		30 x 30 DIN Form A Coil		22 x 30 DIN Form B Coil
		Low Power	High Power	Low Power
Working pressure		0 to 10 bar		
Ambient temperature		-10°C to 60°C (1)	-10°C to 60°C (1)	-25°C to 60°C (1)
Orifice		1.3/1.5mm	1.3/1.5mm	1.2/1.3mm
Nominal Flow Qn		0.84 dm³/s	0.84 dm³/s	0.7 dm³/s
Power	AC Voltages	2,5W	4,5W	3 W
	DC Voltages	3VA	5VA	50 Hz : 5 VA / 60 Hz : 4,2 VA
Voltage tolerance		+/- 10%		
Duty cycle		100%		
Insulation class		F		
Electric connection		DIN A		DIN B
Protection IP65		IP65		
Shock		According to IEC 68-2-6 (2G - from 2 to 150 Hz)		
Vibration		According to IEC 68 - 2 - 7 (15G - 11 m/s)		
Working media		All neutral media such as compressed air and inert gases		

3/2 N.C. CNOMO Operator - Without Coil

Description	Manual override	W (g)	Order code
 Solenoid operator for 30 x 30 DIN Form A Coil Dedicated to Low Power 2,5W / 3VA Coil	No manual override	65	P2FP23N4A
	Pulse non locking	65	P2FP23N4B
	Locking	65	P2FP23N4C
 Solenoid operator for 30 x 30 DIN Form A Coil Dedicated to High Power 4,5W / 5VA Coil	No manual override	65	EV3000100
	Pulse non locking	65	EV3001100
	Locking	65	EV3003100
 Solenoid operator for 22 x 30 DIN Form B Coil Dedicated to Low Power 2,5W / 4,5VA Coil	No manual override	65	1EV0*310
	Pulse non locking	65	1EV1*310
	Locking	65	1EV3*310



30 x 30 DIN Form A and 22 x 30 DIN Form B Coils for CNOMO Operator

Voltage	W (g)	30 x 30 DIN Form A		22 x 30 DIN Form B		
		Order code	Order code	W (g)	Order code	
	12 Vdc	105	P2FCA445	P2FCA545	93	P2FCB345
	24 Vdc	105	P2FCA449	P2FCA549	93	P2FCB349
	48 Vdc	105	P2FCA451	P2FCA551	93	P2FCB351
	12 Vac 50/60 Hz	105	P2FCA440	P2FCA540	93	P2FCB340
	24 Vac 50/60 Hz	105	P2FCA445	P2FCA545	93	P2FCB345
	48 Vac 50/60 Hz	105	P2FCA449	P2FCA549	93	P2FCB349
	110 Vac 50 Hz / 120 Vac 60 Hz	105	P2FCA453	P2FCA553	93	P2FCB353
	230 Vac 50 Hz / 240 Vac 60 Hz	105	P2FCA457	P2FCA557	93	P2FCB357

Spare Solenoid Nuts

Description	Usage	W (g)	Order code	
	Plastic knurled nut	For valve requiring Captured exhaust	5	P2FNPA
	Diffuser plastic nut	For valve requiring Vented exhaust	5	P2FNDA

30 x 30 DIN Form A and 22 x 30 DIN Form B Solenoid Connectors

Description	Characteristic	Visualisation	Cable length	W (g)	Order code	
	30 x 30 DIN Form A connector With standard screw	Standard IP65	No LED	No cable	15	3EV290V10
			24 Vdc/Vac LED	No cable	30	3EV290V20-24
				5 meters	355	3EV290V20-24L5
			110 Vac LED	No cable	30	3EV290V20-110
				5 meters	470	3EV290V20-110L5
			230 Vac LED	No cable	30	3EV290V20-230
	22 x 30 DIN Form B connector With standard screw	Standard IP65	No LED	No cable	15	3EV10V10
				24 Vdc/Vac LED	No cable	20
			5 meters		350	3EV10V20-24L5
			110 Vac LED	No cable	25	3EV10V20-110
				5 meters	355	3EV10V20-110L5
			230 Vac LED	No cable	25	3EV10V20-230
			5 meters	360	3EV10V20-230L5	

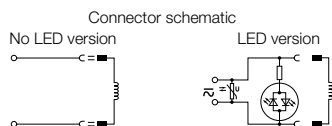

M12 Adaptor for 30 x 30 DIN Form A Coil

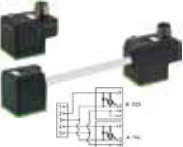
Description	Characteristics	Visualisation	Cable	W (g)	Order code	
	M12 Connector for one coil	24 V AC/DC - 4A	LED	No cable	30	P8C-A626C
	M12 Connector for two coils	24 V AC/DC - 4A	LED	No cable	70	P8C-AM26C

Note: Solenoid pilot operators are fitted to the ISO valve range.
Order the above part numbers for spares.
The operators are supplied with mounting screws and interface 'O' rings.
Coils and connectors must be ordered separately.

Isys ISO - Heavy Duty Applications

Market Applications

- Automotive
- Machine tools
- Mobile



- **Excellent reliability :**

Long life in excess of 30 million operations.

- **Heavy Duty Metal Body**

- **Stable long lasting performances :**

due to wear compensation

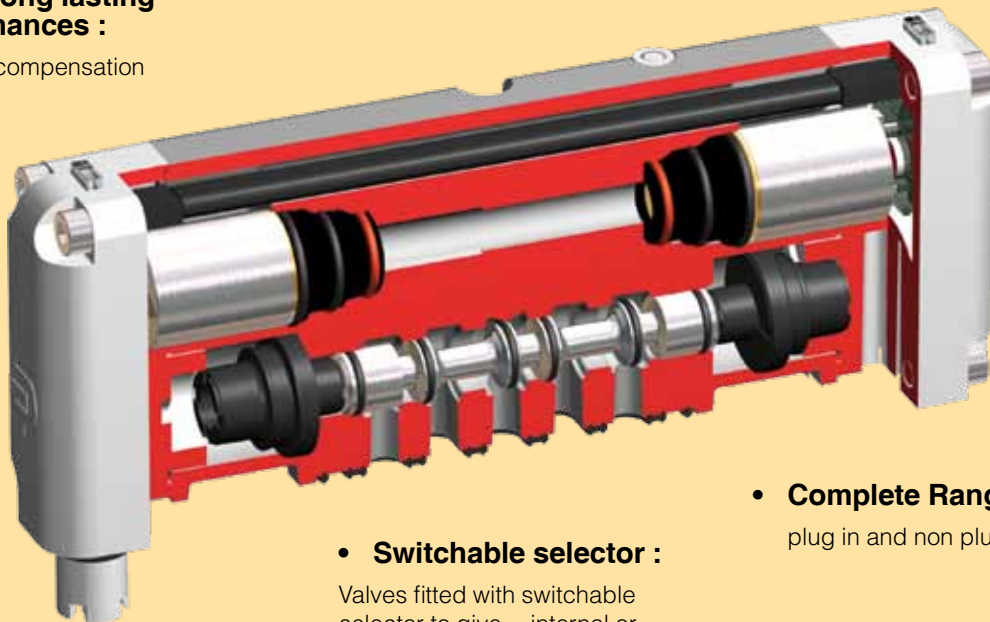

- **Complete Range :**
plug in and non plug in

- **Switchable selector :**

Valves fitted with switchable selector to give internal or external pilot supply

- **WCS Spool Technology**

WCS
Wear Compensating System

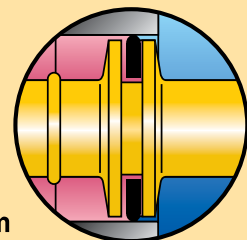

Isys ISO Features

Complete ISO valve range

ISO 15407-1, ISO 15407-2, ISO 5599-1, ISO 5599-2, ISO 4400 DIN A, 12mm, 23 mm, multipole and centralized fieldbus are all feature of Isys ISO valve.

Heavy duty and corrosion resistant body

with a valve body made of painted die casted aluminium and polyamide reinforced glassfiber caps, Isys Iso are suitable for heavy duty environment

External supply selection

In order to use actuator with low pressure, it is possible to connect an external pressure on port 14 to supply both solenoids. Selection is easily made by reversing the gasket under the operator.

High reliability

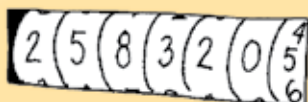

Valves comply with the requirements for the component reliability in accordance with EU Machinery Directive standards EN292-2 and EN983.

Mobile applications

Isys ISO range could be fit with a metal mobile CNOMO solenoid. Available with different coil voltages, allowing +/- 30% voltage tolerance, operating from -15°C to 50°C, under demanding vibration and shock condition, Isys ISO is suitable for mobile and railway applications.

Solenoid valves, CNOMO interface, integrated solenoid



The standard valve is fitted with a 30mm solenoid having DIN 43650 Industrial form A connector for sizes 1, 2 and 3. For sizes 01 and 02, the solenoid is integrated in the valve body.

Central M12 & M23 connection or M12 coil

Sizes 01 & 02 are available with a central M12 connection
 Sizes 1, 2 & 3 are available with a central M12 or M23 connector, compatible with different automotive standard, but also with 30x30 coil having the M12 connection.

Internal or external led & rectifier

Sizes 01 & 02 have integrated Led and rectifier, for all connections. Sizes 1,2, 3 are available with integrated Led and rectifier in the coil or basic Din A coil.

High electrical encapsulation class



The solenoid valves are protected to IP65 with the standard cable plug. Available with DIN A or M12 connection.

Wide range of solenoid connectors / cable plugs for ISO 5599-1



Solenoid connectors are available with or without LED and rectifier and may be selected fitted pre-wired with flying leads.

Bottom or side ported manifolds and subbases

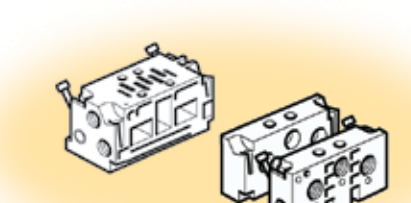

Manifolds are common for ISO 15407-1 & ISO 5599-1. A dedicated range of manifold is available for Isys ISO with integrated electrical connection in the base (plug in)

Insensitive to dirty air

Thanks to large flow passage areas and the large flow diameter of 1.3 in the pilot valves, the ISO valve can be used in normal industrial or mobile environments without any problems of blocking. However the service life of the valve depends on the cleanliness of the air. Please refer to ISO 8573.

Isys ISO Flow Characteristics

Flow capacities in accordance with ISO6358, for 5/2 function. 5/3 function are around 10 to 20% less

Technical Data Isys ISO Size 02

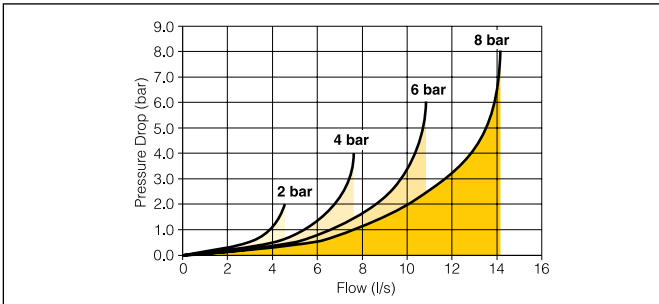

Operating pressure.	
5/2 Spring return	2,0 - 10 bar
5/2 Differential	2,0 - 10 bar
5/2 Double solenoid	2,0 - 10 bar
5/3 Double solenoid	2,5 - 10 bar
Working temperature.	-15°C to + 50°C
Flow (acc. to ISO 6358)	c = 1,5 NI/s x bar b = 0,25 Qn = 6,5 l/s Qmax = 10,8 l/s

Technical Data Isys ISO Size 01

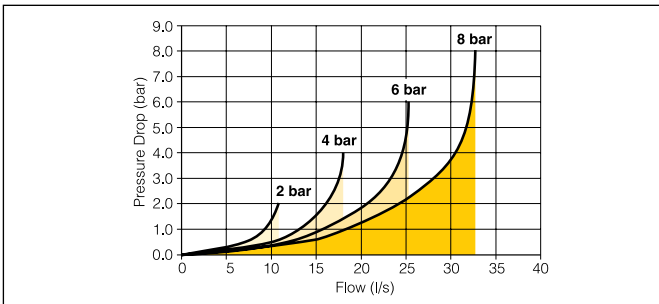

Operating pressure.	
5/2 Spring return	2,0 - 10 bar
5/2 Differential	1,7 - 10 bar
5/2 Double solenoid	1,7 - 10 bar
5/3 Double solenoid	2,5 - 10 bar
Working temperature.	-15°C to + 50°C
Flow (acc. to ISO 6358)	c = 3,6 NI/s x bar b = 0,30 Qn = 15,3 l/s Qmax = 25,3 l/s

Technical Data Isys ISO Size 1

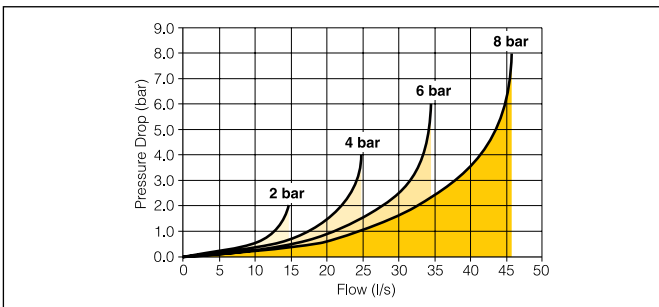

Operating pressure.	
5/2 Spring return	2,4 - 10 bar
5/2 Differential	1,7 - 10 bar
5/2 Double solenoid	1,7 - 10 bar
5/3 Double solenoid	2,5 - 10 bar
Working temperature.	-15°C to + 50°C
Flow (acc. to ISO 6358)	c = 5,0 NI/s x bar b = 0,30 Qn = 20,8 l/s Qmax = 34,5 l/s

Technical Data Isys ISO Size 2

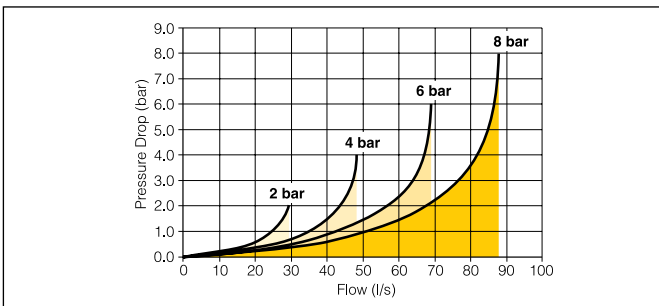

Operating pressure.	
5/2 Spring return	3,1 - 10 bar
5/2 Differential	1,7 - 10 bar
5/2 Double solenoid	1,7 - 10 bar
5/3 Double solenoid	3,5 - 10 bar
Working temperature.	-15°C to + 50°C
Flow (acc. to ISO 6358)	c = 9,7 NI/s x bar b = 0,35 Qn = 42,0 l/s Qmax = 69,0 l/s

Technical Data Isys ISO Size 3

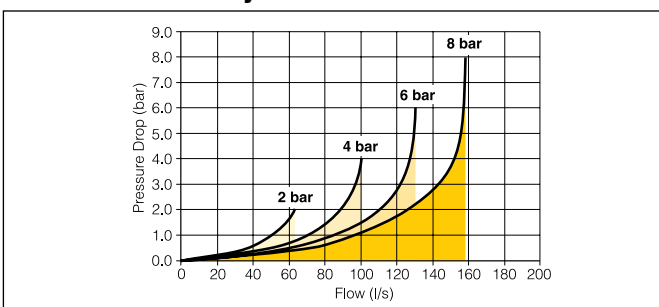

Operating pressure.	
5/2 Spring return	3,1 - 10 bar
5/2 Differential	2,5 - 10 bar
5/2 Double solenoid	2,5 - 10 bar
5/3 Double solenoid	3,5 - 10 bar
Working temperature.	-15°C to + 50°C
Flow (acc. to ISO 6358)	c = 18,7 NI/s x bar b = 0,35 Qn = 83,7 l/s Qmax = 130,8 l/s

Isys ISO Material Specification and Characteristics

Material specification

Valve body:	Die cast aluminium
End cover:	PBT
Spool:	Aluminium + nitrile rubber
Piston:	Acetal plastic
End cover sealing:	Nitrile rubber
Fasteners:	Zinc plated steel

HA & HB Solenoids

Minimum operating voltage:	DC 20,4 V, AC 102 V
Power:	DC 1W, AC 2VA
Bi polar:	
Surge suppressor:	Standard
Light indicator:	Standard

Characteristics

Fluid:	Air, inert gas filtered 40u class 5 according to ISO 8573-1 dry class 4 according to ISO 8573-1 non-lubricated, or lubricated -20° to + 70°
Storage temperature	
Vibration, according to IEC 68-2-6	2G 2 to 150Hz
Shock, according to IEC 68-2-7	15G 11ms
Manual override	Non-locking, other type on request

Plug-in Solenoids

Minimum operating voltage:	DC 20,4 V, AC 102 V
Power:	DC 3W, AC 4,5VA
Bi polar:	
Surge suppressor:	On lighted coils
Light indicator:	Standard

Certification

CSA / C-US approved	
EMC / CE mark.	According to EN 61 000-6-2
Dust & water protection	IP65 according to EN 60529

Changeover time (ms) at 6 bar - Actua. / Return

Valve Function	Solenoid Operated Valves						Pneumatic Operated Valves						
	15407-1-M12 15407-2 - Plug-in		5599-1 - CNOMO operator			5599-1-M12 5599-2 - Plug-in			15407-1		5599-1		
	02	01	1	2	3	1	2	3	02	01	1	2	3
	20/40	20/45	25/35	40/70	70/80	30/40	45/70	75/80	15/30	15/40	20/30	35/70	65/75
	15/40	15/50	25/45	35/80	55/85	30/50	40/80	60/85	10/30	15/35	20/40	30/80	50/85
	10/10	10/10	15/15	20/20	25/25	20/20	25/25	30/30	8/8	10/10	12/12	16/16	20/20
	15/60	15/50	15/60	30/75	23/80	20/65	35/80	40/85	15/35	15/40	15/55	20/70	30/80
	15/60	15/50	15/60	30/75	23/80	20/65	35/80	40/85	15/35	15/40	15/55	20/70	30/80
	15/60	15/50	15/60	30/75	23/80	20/65	35/80	40/85	15/35	15/40	15/55	20/70	30/80

Isys ISO - 15407-1 - Pneumatic remote pilot operated

Order chart



H B 3 WX 000 XX A

Size	
B	ISO 15407 - 18mm
A	ISO 15407 - 26mm

Valve type function	
3	Single remote pilot, 2 position - Differential
4	Double remote pilot, 2 position
8	Double remote pilot, 3 position - APB
9	Double remote pilot, 3 position - CE
0	Double remote pilot, 3 position - PC
F	Single solenoid, 2 position, Differential, spring assist

Shaded part numbers are standard

Isys ISO - 15407-1 - Integrated M12 connector

Order chart



H B 1 WX B G 2 G9 000F A

Size	
B	ISO 15407 - 18mm
A	ISO 15407 - 26mm

Pilot source / Pilot exhaust	
B	Internal pilot
L	External pilot

Voltage	
G9	24 Vdc

M12 connector	
2	1 connector

Valve type function	
1	Single solenoid, 2 position - Differential
2	Double solenoid, 2 position
5	Double solenoid, 3 position - APB
6	Double solenoid, 3 position - CE
7	Double solenoid, 3 position - PC
E	Single solenoid, 2 position, Differential, spring assist

Overrides	
G	Non-locking, flush, push - w/ light
H	Locking, flush, push / turn - w/ light



Shaded voltage part numbers are available from stock. Unshaded part numbers are available on request but will be subject to minimum order quantities. Otherwise order coil/solenoid and valve separately.

Shaded part numbers are standard

Isys ISO 15407-1 - Sizes 02 & 01

Pneumatic remote pilot operated

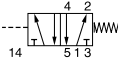
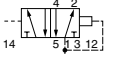
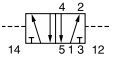

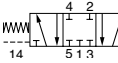
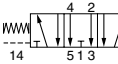
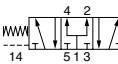



Oriented side 14, LED & Surge suppressor

	Symbol	Description	Size	Weight (g)	Order code	
		5/2 Air pilot - Spring return	02 - 18 mm	150	HBFWX000XXA	
			01 - 26 mm	250	HAFWX000XXA	
		5/2 Air pilot - Differential	02 - 18 mm	150	HB3WX000XXA	
			01 - 26 mm	250	HA3WX000XXA	
HB 18 mm		5/2 Double air pilot	02 - 18 mm	165	HB4WX000XXA	
			01 - 26 mm	265	HA4WX000XXA	
		5/3 Closed Center	02 - 18 mm	165	HB8WX000XXA	
			01 - 26 mm	265	HA8WX000XXA	
		5/3 Vented Center	02 - 18 mm	165	HB9WX000XXA	
			01 - 26 mm	265	HA9WX000XXA	
	HA 26 mm		5/3 Pressurised Center	02 - 18 mm	165	HB0WX000XXA
				01 - 26 mm	265	HA0WX000XXA

Isys ISO 15407-1 - Sizes 02 & 01

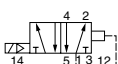
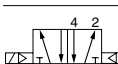
With 24 Vdc / 1 W built-in coil - Integrated M12 connector

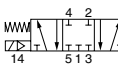
Oriented side 14, LED & Surge suppressor

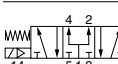
	Symbol	Description	Size	Weight (g)	Order code	
		5/2 Single solenoid - Spring return	02 - 18 mm	150	HBEXWBG2G9000FA	
			01 - 26 mm	250	HAEXWBG2G9000FA	
		5/2 Single solenoid - Differential	02 - 18 mm	150	HB1WXBG2G9000FA	
			01 - 26 mm	250	HA1WXBG2G9000FA	
HB 18 mm		5/2 Double solenoid	02 - 18 mm	165	HB2WXBG2G9000FA	
			01 - 26 mm	265	HA2WXBG2G9000FA	
		5/3 Closed Center	02 - 18 mm	165	HB5WXBG2G9000FA	
			01 - 26 mm	265	HA5WXBG2G9000FA	
		5/3 Vented Center	02 - 18 mm	165	HB6WXBG2G9000FA	
			01 - 26 mm	265	HA6WXBG2G9000FA	
	HA 26 mm		5/3 Pressurised Center	02 - 18 mm	165	HB7WXBG2G9000FA
				01 - 26 mm	265	HA7WXBG2G9000FA

ISO 20401

4-Pin Male / Single Solenoid

4-PIN Micro
 (Top Cover)

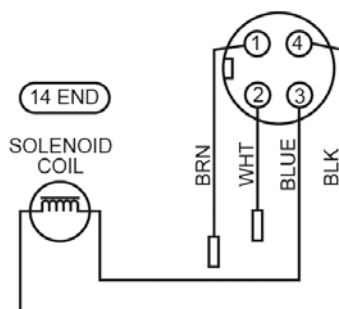

ISO 20401

4-Pin Male / Double Solenoid

4-PIN Micro
 (Top Cover)

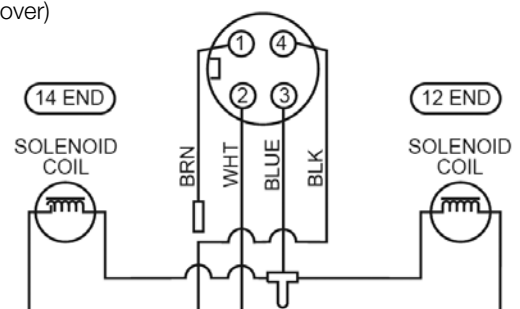

Isys ISO - ISO 5599-1 - CNOMO - Operator - Sizes 1, 2 & 3

Order chart

H 1 E WX B B L 49 D

Size	
1	ISO 5599-1 - Size 1
2	ISO 5599-1 - Size 2
3	ISO 5599-1 - Size 3

Pilot source / Pilot exhaust	
B	Internal pilot
X*	External pilot

* Must be specified when using Sandwich regulators

Voltage	
42	24 VAC
49	24 VDC
53	120 VAC
57	230 VAC
XX	CNOMO operator only without coil

Shaded voltage part numbers are available from stock.
 Unshaded part numbers are available on request but will be subject to minimum order quantities.
 Otherwise order coil/solenoid and valve separately.

Valve type function	
1	Single solenoid, 2 position - Differential
2	Double solenoid, 2 position
5	Double solenoid, 3 position - APB
6	Double solenoid, 3 position - CE
7	Double solenoid, 3 position - PC
E	Single solenoid, 2 position, Differential, spring assist

DIN connector	
L	30 x 30 DIN form A
N	CNOMO operator only without coil

Overrides	
B	Non-locking, flush, push
C	Locking, flush, push / turn

Shaded part numbers are standard

Isys ISO 5599-1 - Sizes 1, 2 & 3 CNOMO operator with 30 x 30 DIN Form A / 24 Vdc / 2,7 W solenoid

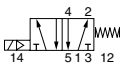
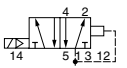
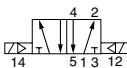
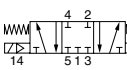
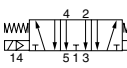
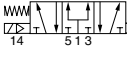
Symbol	Description	Size	Weight (g)	Order code
	5/2 Single solenoid - Spring return	1 - 43 mm	770	H1EWXBBL49D
		2 - 56 mm	1190	H2EWXBBL49D
		3 - 71 mm	1470	H3EWXBBL49D
	5/2 Single solenoid - Differential	1 - 43 mm	770	H11WXBBL49D
		2 - 56 mm	1190	H21WXBBL49D
		3 - 71 mm	1470	H31WXBBL49D
	5/2 Double solenoid	1 - 43 mm	940	H12WXBBL49D
		2 - 56 mm	1360	H22WXBBL49D
		3 - 71 mm	1640	H32WXBBL49D
	5/3 Closed Center	1 - 43 mm	940	H15WXBBL49D
		2 - 56 mm	1360	H25WXBBL49D
		3 - 71 mm	1640	H35WXBBL49D
	5/3 Vented Center	1 - 43 mm	940	H16WXBBL49D
		2 - 56 mm	1360	H26WXBBL49D
		3 - 71 mm	1640	H36WXBBL49D
	5/3 Pressurised Center	1 - 43 mm	940	H17WXBBL49D
		2 - 56 mm	1360	H27WXBBL49D
		3 - 71 mm	1640	H37WXBBL49D

Solenoid connectors & cable plug to be ordered separately. See solenoid section

Isys ISO 5599-1 - Sizes 1, 2 & 3 CNOMO operator without coil

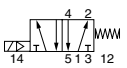
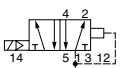
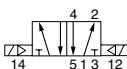
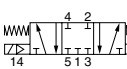
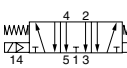
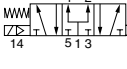
Symbol	Description	Size	Weight (g)	Order code
	5/2 Single solenoid - Spring return	1 - 43 mm	650	H1EWXBBL49D
		2 - 56 mm	1070	H2EWXBBL49D
		3 - 71 mm	1350	H3EWXBBL49D
	5/2 Single solenoid - Differential	1 - 43 mm	650	H11WXBBL49D
		2 - 56 mm	1070	H21WXBBL49D
		3 - 71 mm	1350	H31WXBBL49D
	5/2 Double solenoid	1 - 43 mm	700	H12WXBBL49D
		2 - 56 mm	1120	H22WXBBL49D
		3 - 71 mm	1400	H32WXBBL49D
	5/3 Closed Center	1 - 43 mm	700	H15WXBBL49D
		2 - 56 mm	1120	H25WXBBL49D
		3 - 71 mm	1400	H35WXBBL49D
	5/3 Vented Center	1 - 43 mm	700	H16WXBBL49D
		2 - 56 mm	1120	H26WXBBL49D
		3 - 71 mm	1400	H36WXBBL49D
	5/3 Pressurised Center	1 - 43 mm	700	H17WXBBL49D
		2 - 56 mm	1120	H27WXBBL49D
		3 - 71 mm	1400	H37WXBBL49D

30 x 30 DIN Form A or 22 x 30 DIN Form B solenoid & solenoid connectors to be ordered separately. See solenoid section

Isys ISO 5599-1 Sizes 1, 2 & 3 - Integrated M12 connection

Order chart



H 1 E WX B G 2B 9 000 F D

Size	
1	ISO 5599-1 - Size 1
2	ISO 5599-1 - Size 2
3	ISO 5599-1 - Size 3

Pilot source / Pilot exhaust	
B	Internal pilot
X*	External pilot

* Must be specified when using Sandwich regulators

Voltage	
9	24 VDC

Wiring options	
F	Standard

Valve type function	
1	Single solenoid, 2 position - Differential
2	Double solenoid, 2 position
5	Double solenoid, 3 position - APB
6	Double solenoid, 3 position - CE
7	Double solenoid, 3 position - PC
E	Single solenoid, 2 position, Differential, spring assist

Enclosure	
2B	One central connector per distributor
61	One built-in connector per coil

Overrides / Lights	
G	Non-locking, flush, push - w/ light
H	Locking, flush, push / turn - w/ light

Shaded part numbers are standard

Isys ISO 5599-1 Size 1 / 2 / 3 Remote Pilot

Order chart





H 1 F WX 000 XX D

Size	
1	ISO 5599-1 - Size 1
2	ISO 5599-1 - Size 2
3	ISO 5599-1 - Size 3

Valve type function	
3	Single remote pilot, 2 position - Differential
4	Double remote pilot, 2 position
8	Double remote pilot, 3 position - APB
9	Double remote pilot, 3 position - CE
0	Double remote pilot, 3 position - PC
F	Single remote pilot, 2 position, Differential, spring assist

Shaded part numbers are standard

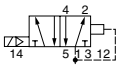
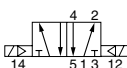
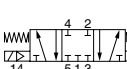
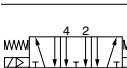
Isys ISO 5599-1 - Sizes 1, 2 & 3 CNOMO operator with Central M12 connector / 24 Vdc / 2,7 W solenoid

Symbol	Description	Size	Weight (g)	Order code
	5/2 Single solenoid - Spring return	1 - 43 mm	770	H1EWXBG2B9000FD
		2 - 56 mm	1290	H2EWXBG2B9000FD
		3 - 71 mm	1570	H3EWXBG2B9000FD
	5/2 Single solenoid - Differential	1 - 43 mm	770	H11WXBG2B9000FD
		2 - 56 mm	1290	H21WXBG2B9000FD
		3 - 71 mm	1570	H31WXBG2B9000FD
	5/2 Double solenoid	1 - 43 mm	1040	H12WXBG2B9000FD
		2 - 56 mm	1460	H22WXBG2B9000FD
		3 - 71 mm	1740	H32WXBG2B9000FD
	5/3 Closed Center	1 - 43 mm	1040	H15WXBG2B9000FD
		2 - 56 mm	1460	H25WXBG2B9000FD
		3 - 71 mm	1740	H35WXBG2B9000FD
	5/3 Vented Center	1 - 43 mm	1040	H16WXBG2B9000FD
		2 - 56 mm	1460	H26WXBG2B9000FD
		3 - 71 mm	1740	H36WXBG2B9000FD
	5/3 Pressurised Center	1 - 43 mm	1040	H17WXBG2B9000FD
		2 - 56 mm	1460	H27WXBG2B9000FD
		3 - 71 mm	1740	H37WXBG2B9000FD

ISO 20401 4-Pin Male / Single Solenoid

4-PIN Micro
(Top Cover)

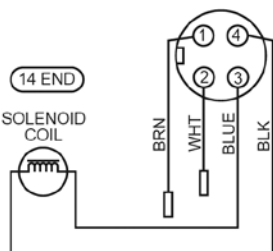

ISO 20401 4-Pin Male / Double Solenoid

4-PIN Micro
(Top Cover)

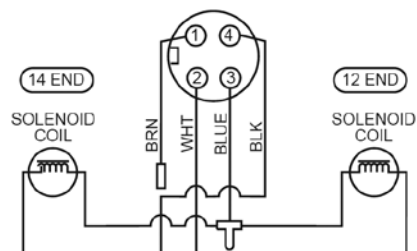

Isys ISO 5599-1 - Sizes 1, 2 & 3 Pneumatic Remote Pilot operated valve

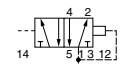
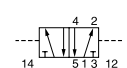
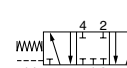
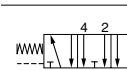
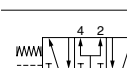
Symbol	Description	Size	Weight (g)	Order code
	5/2 Air pilot - Spring return	1 - 43 mm	600	H1FWX000XXD
		2 - 56 mm	1020	H2FWX000XXD
		3 - 71 mm	1300	H3FWX000XXD
	5/2 Air pilot - Differential	1 - 43 mm	600	H13WX000XXD
		2 - 56 mm	1020	H23WX000XXD
		3 - 71 mm	1300	H33WX000XXD
	5/2 Double Air pilot	1 - 43 mm	600	H14WX000XXD
		2 - 56 mm	1020	H24WX000XXD
		3 - 71 mm	1300	H34WX000XXD
	5/3 Closed Center	1 - 43 mm	600	H18WX000XXD
		2 - 56 mm	1020	H28WX000XXD
		3 - 71 mm	1300	H38WX000XXD
	5/3 Vented Center	1 - 43 mm	600	H19WX000XXD
		2 - 56 mm	1020	H29WX000XXD
		3 - 71 mm	1300	H39WX000XXD
	5/3 Pressurised Center	1 - 43 mm	600	H10WX000XXD
		2 - 56 mm	1020	H20WX000XXD
		3 - 71 mm	1300	H30WX000XXD

30 x 30 DIN Form A or 22 x 30 DIN Form B solenoid & solenoid connectors to be ordered separately. See solenoid section

ISO 15407-1 Subbases & Manifolds

Side ported individual subbase - ISO 15407-1 - Sizes 02 & 01

Description	Size	Port Size	Weight (g)	Order code
 <p>Individual Subbase Can be used for External pilot supply or Single or Double pneumatic remote pilot</p>	02 - 18 mm	1/8 BSPP	70	PL02-01-70
		1/8 NPT	70	PL02-01-80
	01 - 26 mm	1/4 BSPP	120	PL01-02-70
		1/4 NPT	120	PL01-02-80







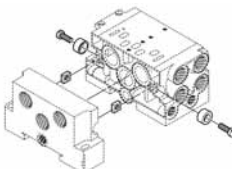

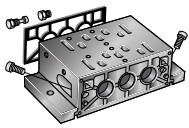
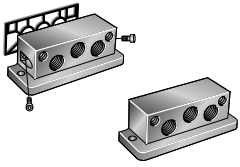

Front ported manifold & End plate - ISO 15407-1 - Sizes 02 & 01

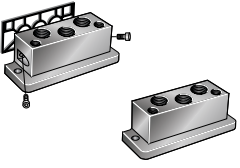
Description	Size	Port Size	Weight (g)	Order code
 <p>Two position manifold base Can be used for External pilot supply Cannot be used for remote pilot</p>	02 - 18 mm	1/8 BSPP	140	PJLP02-201-70
		1/8 NPT	140	PJLP02-201-80
	01 - 26 mm	1/4 BSPP	700	PJLP01-202-70
		1/4 NPT	700	PJLP01-202-80
<p>Two position manifold base Can be used for External pilot supply using #14 or Single or Double pneumatic remote pilot</p>	01 - 26 mm	1/4 BSPP	730	PJL01-202-70
		1/4 NPT	730	PJL01-202-80
<p>End plate kit</p>	02 - 18 mm	1/4 BSPP	150	PEJ02-02-70
		1/4 NPT	150	PEJ02-02-80
	01 - 26 mm	3/8 BSPP	520	PEJ01-03-70
		3/8 NPT	520	PEJ01-03-80

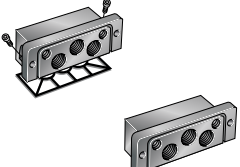
Accessories

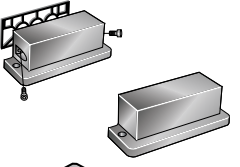
Description	Size	Weight (g)	Order code
 <p>Blanking plate</p>	02 - 18 mm	40	DX02BLK
	01 - 26 mm	50	DX01BLK
<p>Blanking plug</p>	02 - 18 mm	10	DX02BD0
	01 - 26 mm	20	DX01BD0
 <p>Front Ported Manifold Assembling Kit Including 10 Bolts, 10 Washers & 10 Nuts</p>	02 - 18 mm	120	DX02M2MB
	01 - 26 mm	120	DX01M2MB

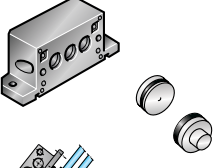
Bottom ported manifold & End plate - ISO 15407-1 - Sizes 02 & 01



Description		Size	Port Size	Weight (g)	Order code	
	Two valve position manifold	Int. pilot supply	02 - 18 mm	1/8 BSPP	200	P2V-AM511PB
			01 - 26 mm	1/4 BSPP	400	P2V-BM512PB
	Including seal, fitting screws and plugs.	Ext. pilot supply	02 - 18 mm	1/8 BSPP	200	P2V-AM511NB
			01 - 26 mm	1/4 BSPP	400	P2V-BM512NB
	Side ported	Left end plate	02 - 18 mm	1/4 BSPP	180	P2V-AM512GS
		Including seal and fitting screws	01 - 26 mm	3/8 BSPP	210	P2V-BM513GS
		Right end plate	02 - 18 mm	1/4 BSPP	180	P2V-AM512HS
			01 - 26 mm	3/8 BSPP	210	P2V-BM513HS
	Top ported	Left end plate	02 - 18 mm	1/4 BSPP	180	P2V-AM512GT
		Including seal and fitting screws	01 - 26 mm	3/8 BSPP	210	P2V-BM513GT
		Right end plate	02 - 18 mm	1/4 BSPP	180	P2V-AM512HT
			01 - 26 mm	3/8 BSPP	210	P2V-BM513HT
	Bottom ported	Left end plate	02 - 18 mm	1/4 BSPP	180	P2V-AM512GB
		Including seal and fitting screws	01 - 26 mm	3/8 BSPP	220	P2V-BM513GB
		Right end plate	02 - 18 mm	1/4 BSPP	180	P2V-AM512HB
			01 - 26 mm	3/8 BSPP	220	P2V-BM513HB
	End cover	Left end plate	02 - 18 mm		190	P2V-AM500G0
		Including seal and fitting screws	01 - 26 mm		240	P2V-BM500G0
		Right end plate	02 - 18 mm		190	P2V-AM500H0
			01 - 26 mm		240	P2V-BM500H0
	Size manifolds adaptor plate	01 to 02		330	P2V-AM500BE	
	Plug	Left end plate	02 - 18 mm		4	P2V-AK0P
			01 - 26 mm		10	P2V-BK0P
	Angle mounting set		01 & 02		140	P2V-AK0M
	O-ring stp seal		01 & 02		70	9304331543

ISO 5599-1 Subbase & Manifolds

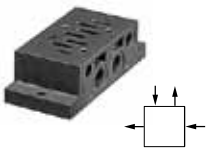
VDMA Side Ported Subbases

Description	Size	Port size	Weight (g)	Order code
 <p>Subbases VDMA Side port according to VDMA</p>	1 - 43mm	G1/4	160	P2N-VS512SD
	2 - 56mm	G3/8	280	P2N-WS513SD
	3 - 71mm	G1/2	350	P2N-YS514SD

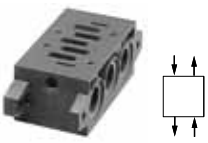
VDMA Bottom Ported Manifold

Description	Size	Port size	Weight (g)	Order code
 <p>VDMA Form C Bottom port according to VDMA</p>	1 - 43mm	G1/4	240	P2N-VM512MB
	2 - 56mm	G3/8	360	P2N-WM513MB
	3 - 71mm	G1/2	700	P2N-YM514MB
 <p>VDMA Transition plate Size 1 to Size 3 Kit includes: Transition plate only</p>	1 to 3	G1/4		P2N-VM500AK
 <p>VDMA Form D - End plate According to VDMA</p>	1 - 43mm	G3/8	210	P2N-VM513ES
	2 - 56mm	G1/2	360	P2N-WM514ES
	3 - 71mm	G1	680	P2N-YM518ES
<p>VDMA Isolation - Main galley According to VDMA</p> <p>Kit includes: (1) Isolator plug.</p>	1 - 43mm			P2N-VK0P
	2 - 56mm			P2N-WK0P
	3 - 71mm			P2N-YK0P

Accessories

Description	Size	Port size	Weight (g)	Order code
 <p>Blanking plate</p> <p>Kit includes: (1) Blanking plate, (1) Gasket and (4) Mounting bolts</p>	1 - 43mm	G1/4	100	P2N-AA5B
	2 - 56mm	G3/8	150	P2N-BA5B
	3 - 71mm	G1/2	200	P2N-CA5B





Side ported subbases

Description	Size	Port size	Weight (g)	Order code BSP	Order code NPT
 Single subbase 1 3 5 2 4 ports & 12 14	1 - 43mm	G1/4	160	PL1-1/4-70	PL1-1/4-80
		G3/8	160	PL1-3/8-70	
	2 - 56mm	G3/8	280	PL2-3/8-70	PL2-3/8-80
		G1/2		P2N-HS514SS	
	3 - 71mm	G1/2		PL3-1/2-70	PL3-1/2-80
		G3/4		P2N-JS516SD	



Bottom ported subbases

Description	Size	Port size	Weight (g)	Order code BSP	Order code NPT
 Single subbase 1 3 5 2 4 ports & 12 14	1 - 43mm	G1/4	370	PD1-1/4-70	PD1-1/4-80
	2 - 56mm	G3/8	590	PD2-3/8-70	PD2-3/8-80
	3 - 71mm	G1/2	590	PD3-1/2-70	

Size 1 bottom ported manifold

Description	Size	Port size	Weight (g)	Order code
 Manifold with bottom ports low profile	1 - 43mm	G1/4	20	P2N-AM512MB
 Connecting block Top or bottom ported connecting block for above manifold "low profile"	1 - 43mm	G3/8	150	P2N-AM513GT
 End End piece for above manifold "low profile"	1 - 43mm	no	6	P2N-AM500J
 Intermediate supply Top or bottom ported intermediate supply for above manifold "low profile"	1 - 43mm	G3/8	140	P2N-AM513BT
 Isolation plugs isolating seal for above manifold "low profile"	1 - 43mm		070	P2N-AK0P

Sizes 1 & 2 side ported manifold

Description	Size	Port size	Weight (g)	Order code
 Manifold Manifold with side port	1 - 43mm	G1/4	240	P2N-EM512MD
	2 - 56mm	G3/8	210	P2N-FM513MD
 End Side ported connecting kit for above manifold with side ports	1 - 43mm	G3/8	360	P2N-EM513ES
	2 - 56mm	G1/2	290	P2N-FM514ES

Plug-in 15407-2, Size 02 (18mm - HB) & 01 (26mm - HA) End Plate Kits

Order chart

PS56 **20T1** **1** **P**

Size	
PS56	ISO 15407-2 - Sizes 02 & 01

Thread type	
0	NPT
1	BSPP 'G'

End Plate Type

Individual connection	
3101	No connector - Use with individually wired base

Multiwiring connection	
20L5	16 Points Terminal Strip
20L2	25-Pin - D-Sub
20L4	12-Pin - M23
20M2	19-Pin - M23
20L3	19-Pin - Round, Brad Harrison

Industrial Communication	
20T0	Turck BL67 Valve driver module - without output
20T1	Turck BL67 Valve driver module - For 16 solenoids
20T2	Turck BL67 Valve driver module - For 32 solenoids
20L6	Isysnet Valve driver module
20M4	Moduflex Fieldbus adaptor

Gateways and I/O modules for Turck BL67, Isysnet and Moduflex Bus must be ordered separately
 (see respective sections)

Individual connection

No connector



Multiwiring connection

Terminal strip



25 Pin's - D-Sub



12 or 19 Pin's



With adaptor for Industrial Communication

TURCK BL67



Isysnet



Moduflex Bus







Plug-in 15407-2, Size 02 (18mm - HB) & 01 (26mm - HA) End Plate Kits
 Left and Right end plates, with pressure exhaust and auxilliary ports

Individual connection

	Description	ISO Size	Port size	Weight (g)	Order code
	No connector To be used with individually wired base	02 & 01	G3/8"	1500	PS5631011P



Multiwiring connection

	Description	ISO Size	Port size	Weight (g)	Order code
	16-Points Terminal Strip	02 & 01	G3/8"	1500	PS5620L51P
	25-Pin, D-Sub	02 & 01	G3/8"	1500	PS5620L21P
	19-Pin, Round, Brad Harrison	02 & 01	G3/8"	1500	PS5620L31P
	M23, 12-Pin	02 & 01	G3/8"	1500	PS5620L41P
	M23, 19-Pin	02 & 01	G3/8"	1500	PS5620M21P

Accessories

	Description	Protection	Length	Weight (g)	Order code
	25-Pin - D-Sub cable	IP40	3 meters	380	P8LMH25M3A
			9 meters	780	P8LMH25M9A
		IP65	9 meters	790	P8LMH25B9A

Adaptors for Industrial Communication

	Description	ISO Size	Port size	Weight (g)	Order code
	Turck BL76 Valve Driver Module Without 16 DO module 16 outputs and blank module to be ordered seaparely (See Turck BL67 section)	02 & 01	G3/8"	1500	PS5620T01P
	Turck BL76 Valve Driver Module For configuration up to 16 solenoids Including 1 x 16 DO & 1 blank module	02 & 01	G3/8"	1500	PS5620T11P
	Turck BL76 Valve Driver Module For configuration up to 32 solenoids Including 2 x 16 DO modules	02 & 01	G3/8"	1500	PS5620T21P
	Isysnet Valve Driver Module For configuration up to 32 solenoids	02 & 01	G3/8"	1500	PS5620L61P
	Moduflex Fieldbus module adaptor	02 & 01	G3/8"	1500	PS5620M41P

For Turck BL67, Isysnet, Moduflex communication gateways and I/O modules, refer to respective sections in following pages.

Plug-in 15407-2, Sizes 02 (18mm - HB) & 01 (26mm - HA) Manifold / Subbase Kits

Order chart

PS55	11	5	4	M	P
------	----	---	---	---	---

ISO 15407-2 Size	
PS56	Size 02 (HB - 18mm)
PS55	Size 01 (HA - 26mm)

Mounting Style	
1	Subbase - Side ported
2	Subbase - Side & Bottom ported
5	Manifold - Front ported
6	Manifold - Front & Bottom ported

Port Size	
Size 02 (HB - 18mm)	
1	1/8" NPT
2	1/8" BSPP
Size 01 (HA - 26mm)	
3	1/4" NPT
4	1/4" BSPP

Enclosure		
Individually wired subbase		
C	Size 01 (HA - 26mm) Terminal Strip	
Collective Wiring Manifold Circuit Board		
J	Single address	For general usage
N*	address	For address 25 - 26 on expended conf.
M	Double address	For general usage
P*	address	For address 25 - 28 on expended conf.

* Including ribbon cable for extension on configurations between 25 to 32 solenoid valves

Subbase Kits



HA Series

2 stations manifold kits



HB Series



HA Series

Plug-in 15407-2 Manifold expended configuration up to 32 solenoid valves

Option 'N'

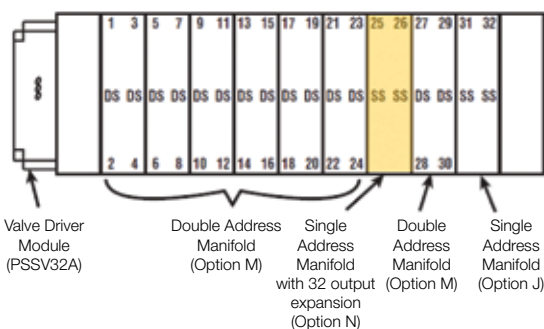

Option 'P'

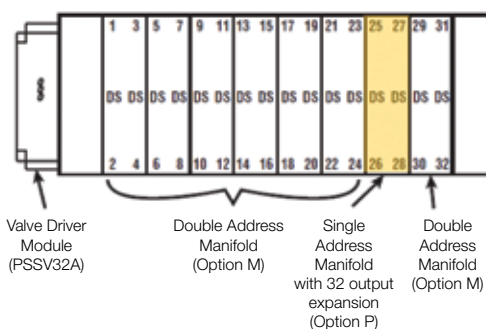

When using an HA or HB manifold base with the "N" Enclosure option:

- **Outputs 1 – 24** can be single or double address bases. Use a base with "J" or "M" Enclosure option.
- **Outputs 25 – 26** are a single address base. Use a base with "N" Enclosure option (this is a single address board with a ribbon connection from the valve driver module).
- **Outputs 27 – 32** can be single or double. Use a base with "J" or "M" Enclosure option.

When using an HA or HB manifold base with the "P" Enclosure option:

- **Outputs 1 – 24** can be single or double address bases. Use a base with "J" or "M" Enclosure option.
- **Outputs 25 – 28** are a double address base. Use a base with "P" Enclosure option (this is a double address board with a ribbon connection from the valve driver module).
- **Outputs 29 – 32** can be single or double. Use a base with "J" or "M" Enclosure option.

Plug-in 15407-2, Size 02 (18mm - HB) & 01 (26mm - HA) Manifold Kits

2 Position Front Ported Manifold

Description		ISO Size	Port size	Weight (g)	Order code	
	Non collective wiring	Terminal strip For single or double solenoid valves	01	G1/4"	520	PS551154CP
	Collective wiring	Single address board For single solenoid valves	02	G1/8"	450	PS561152JP
			01	G1/4"	520	PS551154JP
		Double address board For double solenoid valves	02	G1/8"	450	PS561152MP
			01	G1/4"	520	PS551154MP
	Extension Manifold Including ribbon cable	Single address board For single solenoid valves	02	G1/8"	450	PS561152NP
			01	G1/4"	520	PS551154NP
		Double address board For double solenoid valves	02	G1/8"	450	PS561152PP
			01	G1/4"	520	PS551154PP

2 Position Front and Bottom Ported Manifold

Description		ISO Size	Port size	Weight (g)	Order code	
	Non collective wiring	Terminal strip For single or double solenoid valves	01	G1/4"	520	PS551164CP
	Collective wiring	Single address board For single solenoid valves	02	G1/8"	450	PS561162JP
			01	G1/4"	520	PS551164JP
		Double address board For double solenoid valves	02	G1/8"	450	PS561162MP
			01	G1/4"	520	PS551164MP
	Extension Manifold Including ribbon cable	Single address board For single solenoid valves	02	G1/8"	450	PS561162NP
			01	G1/4"	520	PS551164NP
		Double address board For double solenoid valves	02	G1/8"	450	PS561162PP
			01	G1/4"	520	PS551164PP

Accessories

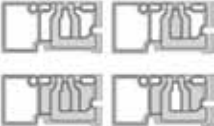
Description		Blocked ports	ISO Size	Port size	Weight (g)	Order code
	Blanking Plate		02	G1/8"	150	PS5634P
			01	G1/4"	160	PS5534P
	Manifold to Manifold gasket kit	No port plugged	02 & 01		40	PS561AP
		#1	02 & 01		60	PS561BP
		#1, 3 & 5	02 & 01		50	PS561CP
		#3 & 5	02 & 01		50	PS561DP

Isys ISO Plug in
Order chart

H B 1 VX B G 0 G9 A

Size	
B	ISO 15407 - 18mm
A	ISO 15407 - 26mm

Pilot source / Pilot exhaust	
B	Internal pilot, port#1 / vented
L	External pilot#14 port / vented

Voltage	
G9	24 VDC
23	115 VAC

Valve type function	
1	Single solenoid, 2 position - Differential
2	Double solenoid, 2 position
5	Double solenoid, 3 position - APB
6	Double solenoid, 3 position - CE
7	Double solenoid, 3 position - PC
E	Single solenoid, 2 position, Air return, spring assist

Shaded voltage part numbers are available from stock.
 Unshaded part numbers are available on request but will be subject to minimum order quantities.
 Otherwise order coil/solenoid and valve separately.



Overrides	
G	Non-locking, flush, push - w/ light
H	Locking, flush, push / turn - w/ light

* Only available with pilot source / pilot exhaust '0'.
 Available on HA only, must use DX01 manifold or HA subbase

Shaded part numbers are standard

Isys ISO Plug-in 15407-2 - Sizes 02 & 01 With 24 Vdc / 1 W built-in coil

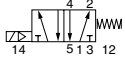
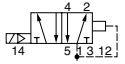
Manual override non locking, LED & surge suppressor

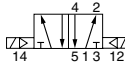
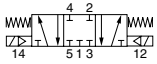
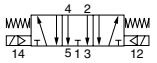
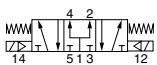
	Symbol	Description	Size	Weight (g)	Order code
 HB 18 mm		5/2 single solenoid - Spring return	02 - 18mm	130	HB5VXBG0G9A
			01 - 26mm	230	HA5VXBG0G9A
		5/2 single solenoid - Differential	02 - 18mm	130	HB1VXBG0G9A
			01 - 26mm	230	HA1VXBG0G9A
 HA 26 mm		5/2 double solenoid	02 - 18mm	145	HB2VXBG0G9A
			01 - 26mm	245	HA2VXBG0G9A
		5/3 Closed center	02 - 18mm	145	HB5VXBG0G9A
			01 - 26mm	245	HA5VXBG0G9A
		5/3 Vented center	02 - 18mm	145	HB6VXBG0G9A
			01 - 26mm	245	HA6VXBG0G9A
	5/3 Pressurised center	02 - 18mm	145	HB7VXBG0G9A	
		01 - 26mm	245	HA7VXBG0G9A	

Plug-in ISO 5599-2, Sizes 1, 2 & 3 End Plate Kits

Order chart

PS40 20L2 1 CP

Size	
PS40	ISO 5599-2 - Size 1
PS41	ISO 5599-2 - Size 2
PS42	ISO 5599-2 - Size 3

Thread type	
0	NPT
1	BSPP 'G'

End Plate Type	
Individual connection	
3101	No connector - Use with individually wired base
Multiwiring connection	
20L2	25-Pin - D-Sub
20L4	12-Pin - M23
20M2	19-Pin - M23
20L3	19-Pin - Round, Brad Harrison
Industrial Communication	
20T0	Turck BL67 Valve driver module - without output
20T1	Turck BL67 Valve driver module - For 16 solenoids
20T2	Turck BL67 Valve driver module - For 32 solenoids
20L6	Isysnet Valve driver module
20M4	Moduflex Fieldbus adaptor

- Moduflex Fieldbus Gateways must be ordered separately (See Moduflex Valve System Technical Catalogue)
- Turck BL67, Isysnet Gateways and I/O modules must be ordered separately (See Turck BL67 or Isysnet section)

Individual connection

No connector



Multiwiring connection

25 Pin's - D-Sub



12 or 19 Pin's



With adaptor for Industrial Communication

TURCK BL67



Isysnet



Moduflex Bus







Plug-in 5599-2, Sizes 1, 2 & 3 End Plate Kits

Left and Right end plates, with pressure exhaust and auxilliary ports

Individual connection

	Description	ISO Size	Port size	Weight (g)	Order code
	No connector	Size 1	G1/2"	1360	PS4031011CP
	To be used with individually wired base	Size 2	G3/4"	1600	PS4131011CP
		Size 3	G3/4"	2800	PS4231011CP





Multiwiring connection

	Description	ISO Size	Port size	Weight (g)	Order code
	25-Pin, D-Sub	Size 1	G1/2"	1360	PS4020L21CP
		Size 2	G3/4"	1600	PS4120L21CP
		Size 3	G3/4"	2800	PS4220L21CP
	19-Pin, Round, Brad Harrison	Size 1	G1/2"	1360	PS4020L31CP
		Size 2	G3/4"	1600	PS4120L31CP
		Size 3	G3/4"	2800	PS4220L31CP
	19-Pin, M23	Size 1	G1/2"	1360	PS4020M21CP
		Size 2	G3/4"	1600	PS4120M21CP
		Size 3	G3/4"	2800	PS4220M21CP
	12-Pin, M23	Size 1	G1/2"	1360	PS4020L41CP
		Size 2	G3/4"	1600	PS4120L41CP
		Size 3	G3/4"	2800	PS4220L41CP

Accessories

	Description	Protection	Length	Weight (g)	Order code
	25-Pin - D-Sub cable	IP40	3 meters	380	P8LMH25M3A
			9 meters	780	P8LMH25M9A
		IP65	9 meters	790	P8LMH25B9A

Adaptors for Industrial Communication

	Description	ISO Size	Port size	Weight (g)	Order code
	Turck BL76 Valve Driver Module Without 16 DO module 16 outputs and blank module to be ordered seaparely (See Turck BL67 section)	Size 1	G1/2"	1400	PS4020T01CP
		Size 2	G3/4"	1600	PS4120T01CP
		Size 3	G3/4"	2800	PS4220T01CP
	Turck BL76 Valve Driver Module For configuration up to 16 solenoids Including 1 x 16 DO & 1 blank module	Size 1	G1/2"	1520	PS4020T11CP
		Size 2	G3/4"	1720	PS4120T11CP
		Size 3	G3/4"	2920	PS4220T11CP
	Turck BL76 Valve Driver Module For configuration up to 32 solenoids Including 2 x 16 DO modules	Size 1	G1/2"	1520	PS4020T21CP
		Size 2	G3/4"	1720	PS4120T21CP
		Size 3	G3/4"	2920	PS4220T21CP
	Isysnet Valve Driver Module For configuration up to 32 solenoids	Size 1	G1/2"	1580	PS4020L61CP
		Size 2	G3/4"	1800	PS4120L61CP
		Size 3	G3/4"	3000	PS4220L61CP
	Moduflex Fieldbus module adaptor	Size 1	G1/2"	1300	PS4020M41CP
		Size 2	G3/4"	1500	PS4120M41CP
		Size 3	G3/4"	2700	PS4220M41CP

For Turck BL67, Isysnet, Moduflex communication gateways and I/O modules, refer to respective sections in following pages.

Plug-in 5599-2, Sizes 1, 2 & 3 Manifold / Subbase Kits

Order chart

PS40	11	5	6	J	CP
-------------	-----------	----------	----------	----------	-----------

ISO 5599-2 Size	
PS40	Size 1 (H1 - 43 mm)
PS41	Size 2 (H2 - 56 mm)
PS42	Size 3 (H3 - 71 mm)

Mounting Style	
1	Subbase - Side ported
5	Manifold - Front ported *
6	Manifold - Front & Bottom ported

* For sizes 2 & 3 only

Port Size	
Size 1 (H1 - 43mm)	
5	3/8" NPT
6	3/8" BSPP
Size 2 (H2 - 56mm)	
7	1/2" NPT
8	1/2" BSPP
Size 3 (H3 - 71mm)	
9	3/4" NPT
0	3/4" BSPP

Note:
 When using the Enclosure 'J' or 'M' option:

12VDC Maximum number of coils energised simultaneously is 13

24VDC Maximum number of coils energised simultaneously is 21

120VAC Coils limited by the number of pins available in the connector:

- 25-Pin D-Sub : 24 coils
- 19-Pin Brad Harrison : 16 coils
- 12-Pin M23 : 8 coils

240VAC Must use 'C' option : Terminal strip

Enclosure	
Individually wired subbase	
C	Terminal Strip
Collective Wiring Manifold Circuit Board	
J	Single address
M	Double address

Subbase kits

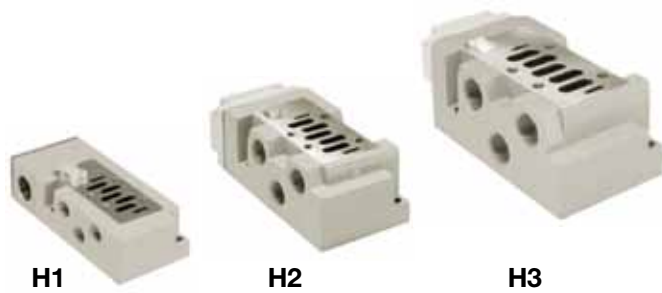

Manifold kits



Plug-in 5599-2, Sizes 1, 2 & 3 Manifold Kits



Single Position Front Ported Manifold

Description		ISO Size	Port size	Weight (g)	Order code
 Non collective wiring Terminal strip For single or double solenoid valves	2 - 56 mm	G1/2"	1260	PS411158CCP	
	3 - 71 mm	G3/4"	2140	PS421150CCP	
	Collective wiring	Single address board For single solenoid valves	2 - 56 mm	G1/2"	1260
	3 - 71 mm	G3/4"	2140	PS421150JCP	
	2 - 56 mm	G1/2"	1260	PS411158MCP	
	3 - 71 mm	G3/4"	2140	PS421150MCP	

Single Position Front & Bottom Ported Manifold

Description		ISO Size	Port size	Weight (g)	Order code
 Non collective wiring Terminal strip For single or double solenoid valves	1 - 43 mm	G3/8"	1000	PS401166CCP	
	2 - 56 mm	G1/2"	1260	PS411168CCP	
	3 - 71 mm	G3/4"	2140	PS421160CCP	
Collective wiring Single address board For single solenoid valves	1 - 43 mm	G3/8"	1000	PS401166JCP	
	2 - 56 mm	G1/2"	1260	PS411168JCP	
	3 - 71 mm	G3/4"	2140	PS421160JCP	
Double address board For double solenoid valves	1 - 43 mm	G3/8"	1000	PS401166MCP	
	2 - 56 mm	G1/2"	1260	PS411168MCP	
	3 - 71 mm	G3/4"	2140	PS421160MCP	

Accessories

Description		ISO Size	Port size	Weight (g)	Order code
 Blanking Plate	1 - 43 mm	G3/8"	150	PS4034CP	
	2 - 56 mm	G1/2"	620	PS4134CP	
	3 - 71 mm	G3/4"	1500	PS4234CP	
 Insulating Plugs	1 - 43 mm	G3/8"	20	PS4032CP	
	2 - 56 mm	G1/2"	40	PS4132CP	
	3 - 71 mm	G3/4"	100	PS4232CP	
 Manifold to Manifold Gasket Kit	1 - 43 mm	G3/8"	20	PS4013P	
	2 - 56 mm	G1/2"	40	PS4113P	
	3 - 71 mm	G3/4"	100	PS4213P	

Isys ISO - 5599-2 - Size 1 / 2 / 3 - Plug in
Order chart

H

1

E

VX

B

G

0

B9

D

Size	
1	ISO 5599-2 - Size 1
2	ISO 5599-2 - Size 2
3	ISO 5599-2 - Size 3

Pilot source / Pilot exhaust	
B	Internal pilot
X*	External pilot

* Must be specified when using Sandwich regulators

Voltage & Frequency **				
	AC		DC	Light & surge sup
	60Hz	50Hz		
42				
45			12	
B9*			24	LED & Sup
23	120	115		LED & Sup
57	240			
XX	Valve less coil			

* Solenoid is blue

Valve type function	
1	Single solenoid, 2 position - Differential
2	Double solenoid, 2 position
5	Double solenoid, 3 position - APB
6	Double solenoid, 3 position - CE
7	Double solenoid, 3 position - PC
E	Single solenoid, 2 position, Differential, spring assist

* Only available with pilot source / pilot exhaust 'O'.

Enclosure	
0	Non, Valve with coil
N	Non, Valve less coil





Overrides / Lights	
B	Non-locking, flush, push - w/o light
C	Locking, flush, push / turn - w/o light
G	Non-locking, flush, push - with light
H	Locking, flush, push / turn - with light

Shaded part numbers are standard

Shaded voltage part numbers are available from stock.
 Unshaded part numbers are available on request but will be subject to minimum order quantities.
 Otherwise order coil/solenoid and valve separately.

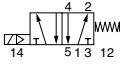
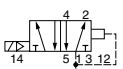
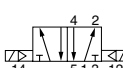





Isys ISO 5599-2 - Sizes 1, 2 & 3

Solenoid operated ISO valve with operator and 24 Vdc / 2,7 W Plug-in coil

Symbol	Description	Size	Weight (g)	Order code
	5/2 single solenoid - Spring return 	1 - 43 mmmm	770	H1EVXBG0B9D
		2 - 56 mm	1190	H2EVXBG0B9D
		3 - 71 mm	1470	H3EVXBG0B9D
	5/2 single solenoid - Differential 	1 - 43 mmmm	770	H11VXBG0B9D
		2 - 56 mm	1190	H21VXBG0B9D
		3 - 71 mm	1470	H31VXBG0B9D
	5/2 double solenoid 	1 - 43 mmmm	940	H12VXBG0B9D
		2 - 56 mm	1360	H22VXBG0B9D
		3 - 71 mm	1640	H32VXBG0B9D
5/3 Closed center 	1 - 43 mmmm	940	H15VXBG0B9D	
	2 - 56 mm	1360	H25VXBG0B9D	
	3 - 71 mm	1640	H35VXBG0B9D	
5/3 Vented center 	1 - 43 mmmm	940	H16VXBG0B9D	
	2 - 56 mm	1360	H26VXBG0B9D	
	3 - 71 mm	1640	H36VXBG0B9D	
5/3 Pressurised center 	1 - 43 mmmm	940	H17VXBG0B9D	
	2 - 56 mm	1360	H27VXBG0B9D	
	3 - 71 mm	1640	H37VXBG0B9D	

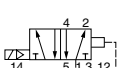
Isys ISO 5599-2 - Sizes 1, 2 & 3

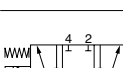
Solenoid operated ISO valve with operator without Plug-in coil

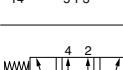
Symbol	Description	Size	Weight (g)	Order code
	5/2 single solenoid - Spring return 	1 - 43 mmmm	650	H1EVXBG0NXXD
		2 - 56 mm	1070	H2EVXBG0NXXD
		3 - 71 mm	1350	H3EVXBG0NXXD
	5/2 single solenoid - Differential 	1 - 43 mmmm	650	H11VXBG0NXXD
		2 - 56 mm	1070	H21VXBG0NXXD
		3 - 71 mm	1350	H31VXBG0NXXD
	5/2 double solenoid 	1 - 43 mmmm	700	H12VXBG0NXXD
		2 - 56 mm	1120	H22VXBG0NXXD
		3 - 71 mm	1400	H32VXBG0NXXD
5/3 Closed center 	1 - 43 mmmm	700	H15VXBG0NXXD	
	2 - 56 mm	1120	H25VXBG0NXXD	
	3 - 71 mm	1400	H35VXBG0NXXD	
5/3 Vented center 	1 - 43 mmmm	700	H16VXBG0NXXD	
	2 - 56 mm	1120	H26VXBG0NXXD	
	3 - 71 mm	1400	H36VXBG0NXXD	
5/3 Pressurised center 	1 - 43 mmmm	700	H17VXBG0NXXD	
	2 - 56 mm	1120	H27VXBG0NXXD	
	3 - 71 mm	1400	H37VXBG0NXXD	

Plug-in Coil for 5599-2 ISO Valve - Sizes 1, 2 & 3

Description	Voltage	Weight (g)	Order code
	12 Vdc	120	PS404145P
	24 Vdc	120	PS4041B9P
	24 Vac	120	PS404142P
	120 Vac	120	PS404123P
	240 Vac	120	PS404157P

Sandwich regulator for Plug-in or not Plug-in ISO 15407 (Sizes 02 & 01) and 5599 (Sizes 1, 2 & 3)

Order chart

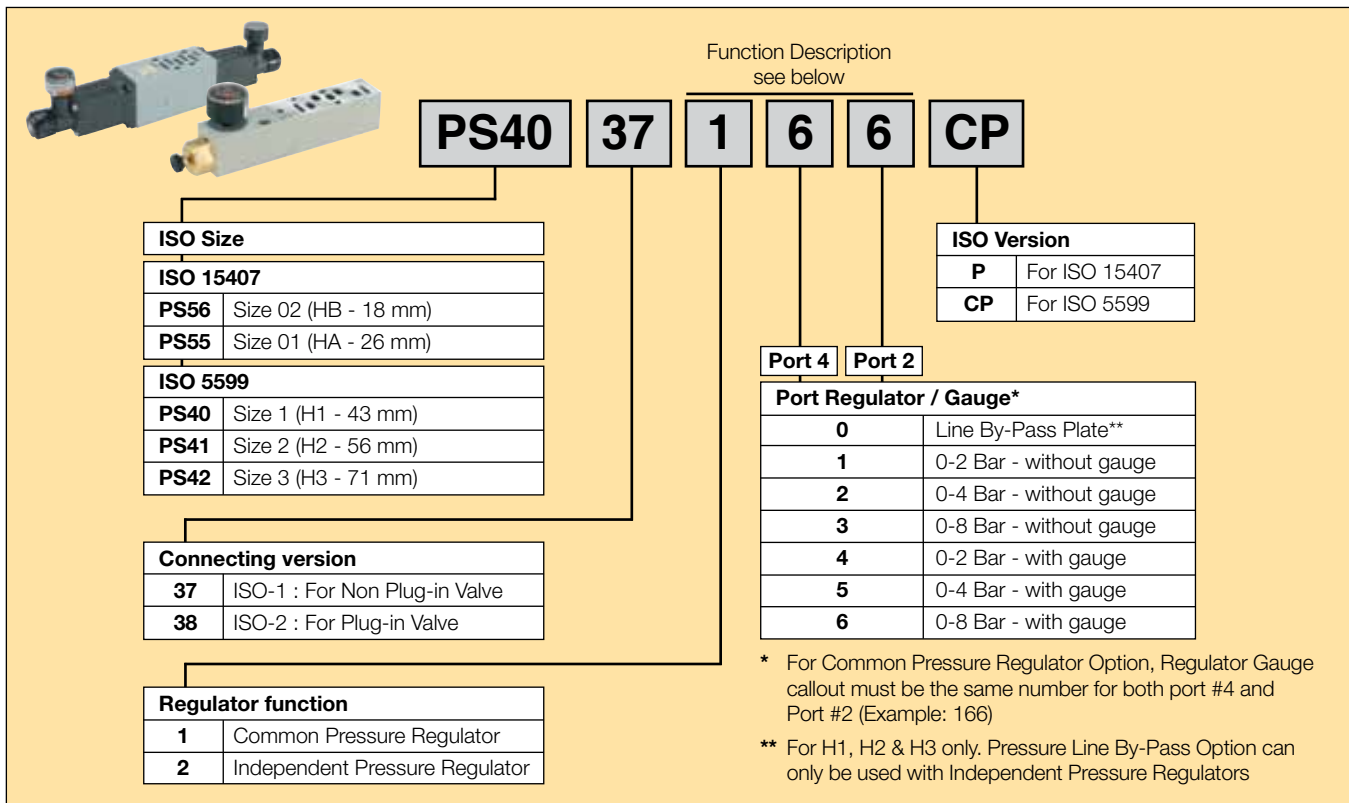

Function Description see below

ISO Size	
ISO 15407	
PS56	Size 02 (HB - 18 mm)
PS55	Size 01 (HA - 26 mm)
ISO 5599	
PS40	Size 1 (H1 - 43 mm)
PS41	Size 2 (H2 - 56 mm)
PS42	Size 3 (H3 - 71 mm)

ISO Version	
P	For ISO 15407
CP	For ISO 5599

Port 4	Port 2
Port Regulator / Gauge*	
0	Line By-Pass Plate**
1	0-2 Bar - without gauge
2	0-4 Bar - without gauge
3	0-8 Bar - without gauge
4	0-2 Bar - with gauge
5	0-4 Bar - with gauge
6	0-8 Bar - with gauge

Connecting version	
37	ISO-1 : For Non Plug-in Valve
38	ISO-2 : For Plug-in Valve

Regulator function	
1	Common Pressure Regulator
2	Independent Pressure Regulator

* For Common Pressure Regulator Option, Regulator Gauge callout must be the same number for both port #4 and Port #2 (Example: 166)
 ** For H1, H2 & H3 only. Pressure Line By-Pass Option can only be used with Independent Pressure Regulators

Pressure Regulators functions

Common port regulation

Provides adjustable regulated air pressure to the valves #1 port which gives the same regulated pressure to both the #2 and #4 port of the manifold or subbase. The regulator is always on the 14 end of the valve.



For HB & HA



For H1, H2 & H3

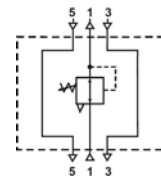

Part number code 1 X X

Independent port regulation

Single Port Regulator

Provides regulated pressure to both ports. Pressure regulation can occur out of the #2 or #4 port of the valve. Full line pressure would be provided with a pass plate.



For H1, H2 & H3

Regulation on port #4

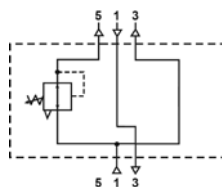

Part number code 2 X 0

Regulation on port #2

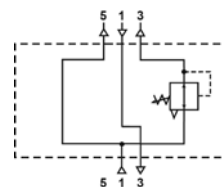

Part number code 2 0 Y

Dual Port Regulator

When using an independent Pressure Sandwich Regulator, the cylinder outlet ports are reversed. The 12 end energizes the #2 port. The 3-position CE and PC functions are also reversed.



For HB & HA





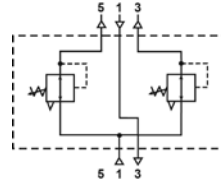

For H1, H2 & H3

Regulation on both ports #4 & #2



Part number code 2 X Y

Sandwich regulator with Gauge

	ISO Size	Regulator function	Pressure On port 4 and / or port 2	w (g)	Order code	
					ISO-1 Non Plug-in	ISO-2 Plug-in
	02 - 18 mm	Common	0 to 4 bar	180	PS5637155P	PS5638155P
		Independent	0 to 8 bar		PS5637166P	PS5638166P
	01 - 26 mm	Common	0 to 4 bar	240	PS5637255P	PS5638255P
		Independent	0 to 8 bar		PS5637266P	PS5638266P
	01 - 26 mm	Common	0 to 4 bar	240	PS5537155P	PS5538155P
		Independent	0 to 8 bar		PS5537166P	PS5538166P
	1 - 43 mm	Common	0 to 4 bar	340	PS4037155CP	PS4038155CP
		Independent	0 to 8 bar		PS4037166CP	PS4038166CP
	1 - 43 mm	Common	0 to 4 bar	340	PS4037255CP	PS4038255CP
		Independent	0 to 8 bar		PS4037266CP	PS4038266CP
	2 - 56 mm	Common	0 to 4 bar	520	PS4137155CP	PS4138155CP
		Independent	0 to 8 bar		PS4137166CP	PS4138166CP
	2 - 56 mm	Common	0 to 4 bar	520	PS4137255CP	PS4138255CP
		Independent	0 to 8 bar		PS4137266CP	PS4138266CP
	3 - 71 mm	Common	0 to 4 bar	1180	PS4237155CP	PS4238155CP
		Independent	0 to 8 bar		PS4237166CP	PS4238166CP
	3 - 71 mm	Common	0 to 4 bar	1180	PS4237255CP	PS4238255CP
		Independent	0 to 8 bar		PS4237266CP	PS4238266CP

How to Configure Sandwich Regulator / Valve Combinations

Ordering Components

- Manifold or Subbase Kit required.
- Sandwich Regulator Kit configured for Internal Pilot as standard.
- Order valve as External Pilot.

Internal Pilot Configuration

Pressure in Base Port 1 feeds regulator configured for Internal Pilot which feeds valve configured for External Pilot.

External Pilot Configuration - H1, H2, H3

An External Pilot pressure in port 12 or 14 of the base feeds through the Sandwich Regulator 12 or 14 galley directly to the 12/14 pilot of the valve. This configuration takes an External Pilot from the 12 port of the base and passes it through the regulator to feed the 12 galley of the valve.

Sandwich Regulator Accessories

	Description	Pressure range	w (g)	Order code
	Gauge kit Including: Gauge 1/8" female to 1/8" female coupling 1/8" male to 1/8" male long nipple	0 to 8 bar	80	PS5651160P

Sandwich Flow Control

	ISO Size	w (g)	Order code	
			ISO-1 Non Plug-in	ISO-2 Plug-in
	02 - 18 mm	180	PS5635P	PS5642P
	01 - 26 mm	240	PS5535P	PS5542P
	1 - 43 mm	340	PS4035CP	PS4042CP
	2 - 56 mm	520	PS4135CP	PS4142CP
	3 - 71 mm	1180	PS4235CP	PS4242CP

Note:

- Both adjustment screws are located on the same 12 end of the unit
- Sandwich Flow Control mounts with its own studs, which means the valve uses standard bolts for mounting
- Sandwich Flow Control is not to be used as a shut off device and is not bubble tight when needles are fully turned down



TURCK BL67 Remote I/O System



Isysnet Fieldbus System





Moduflex Bus System



TURCK BL67 Remote I/O System

The device has four major components :

- Communication Gateway provide the network interface.
- I/O modules provide the field & system interface
- Power feeding modules provide additional power inputs to the TURCK BL67 System
- Valve Driver Adaptor provides control for either 16 or 32 solenoids on a manifold.

2 slots for modularity

- Populated with 1 x 16 DO & 1 blank module for a configuration up to 16 solenoids
- Populated with 2 x 16 DO modules for a configuration up to 32 solenoids

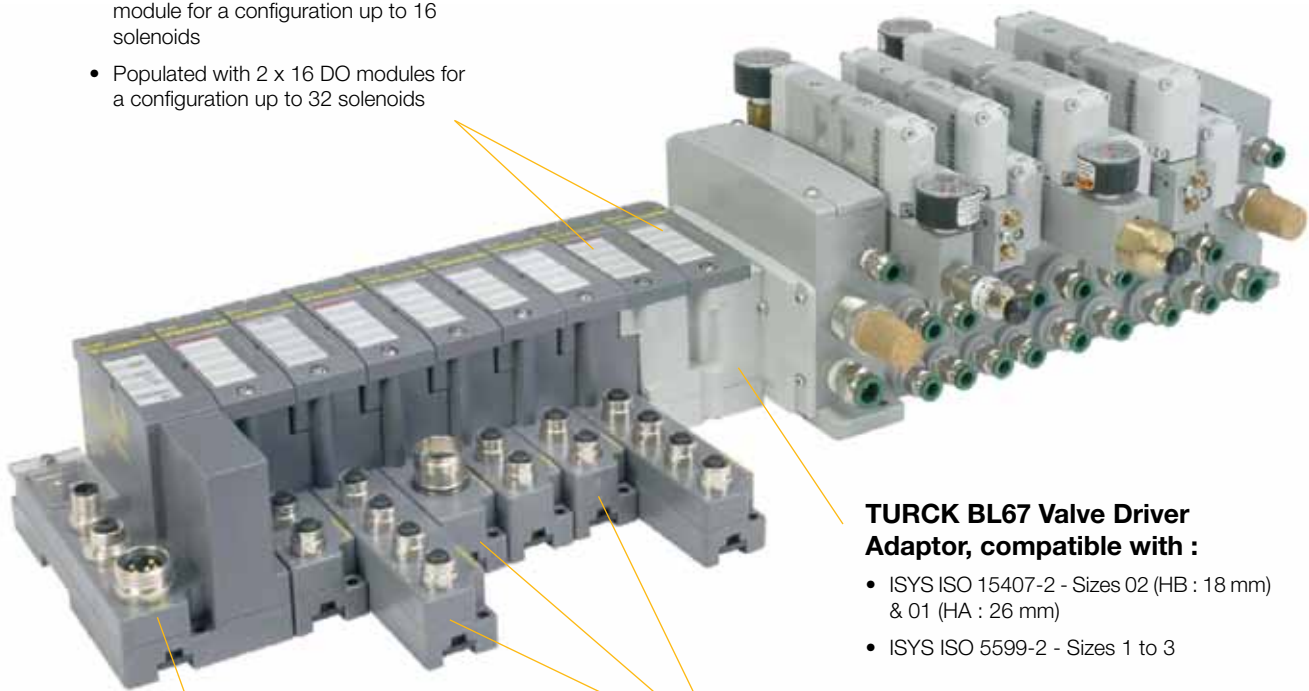

TURCK BL67 Valve Driver Adaptor, compatible with :

- ISYS ISO 15407-2 - Sizes 02 (HB : 18 mm) & 01 (HA : 26 mm)
- ISYS ISO 5599-2 - Sizes 1 to 3

A configurable connection

- M8, M12, M23 with passive sub-base

Simple or Programmable CODESYS Gateway

- Offering a choice between the most popular industrial fieldbus and industrial ethernet protocols



TURCK BL67 Remote I/O System

- With specific modules, the TURCK BL67 Remote I/O System allows decentralised configurations.
- Completed by a programmable gateway, the device can offer a decentralised management topology.

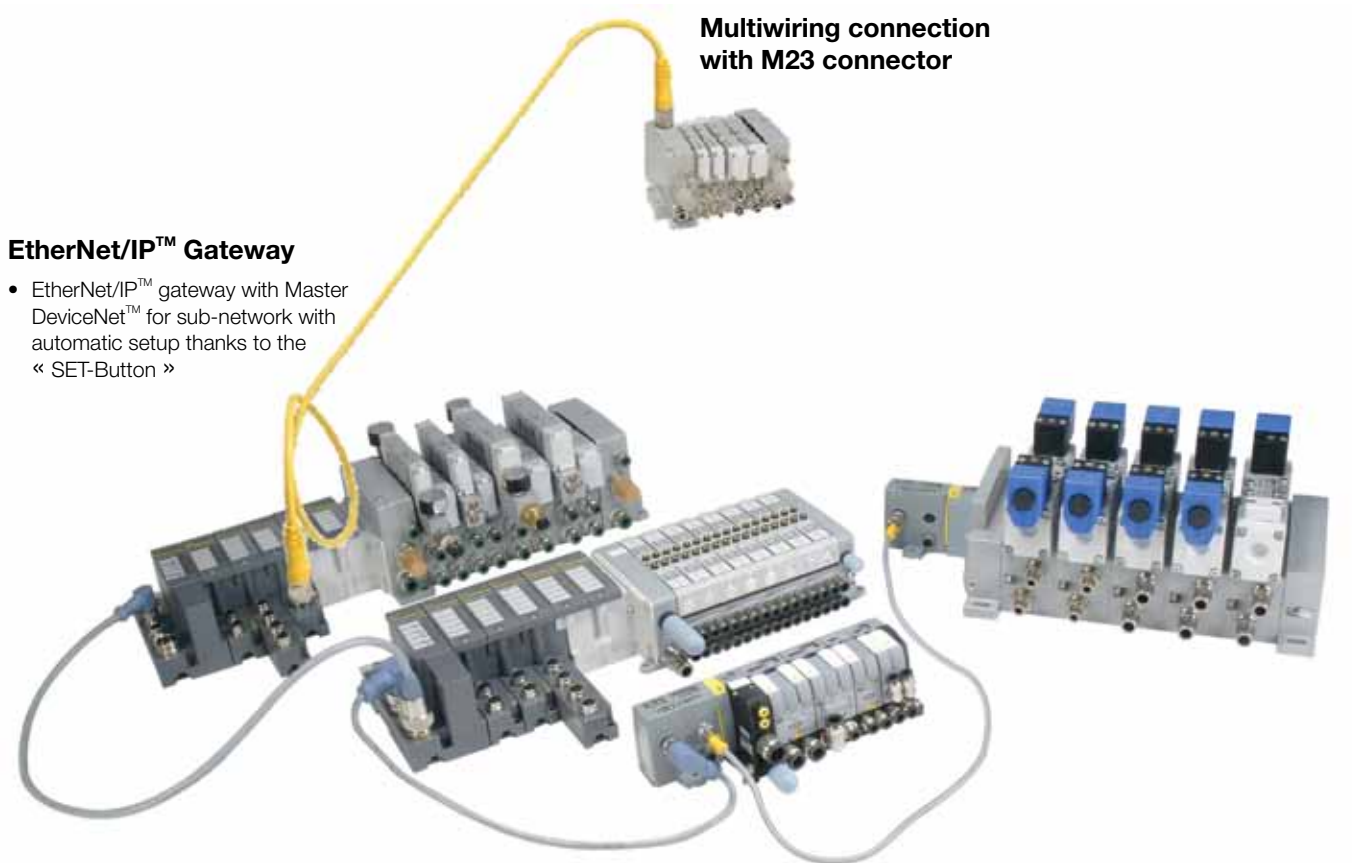

Multiwiring connection with M23 connector

EtherNet/IP™ Gateway

- EtherNet/IP™ gateway with Master DeviceNet™ for sub-network with automatic setup thanks to the « SET-Button »

Programmable Gateway

- Configure / Program any module with RS232, or directly through Ethernet for any module with an Ethernet physical layer.



BL67-1CVI electronic module with BL67-B-1M12

- Offering a CANopen Sub-Network connectivity



TURCK BL67 Remote I/O System

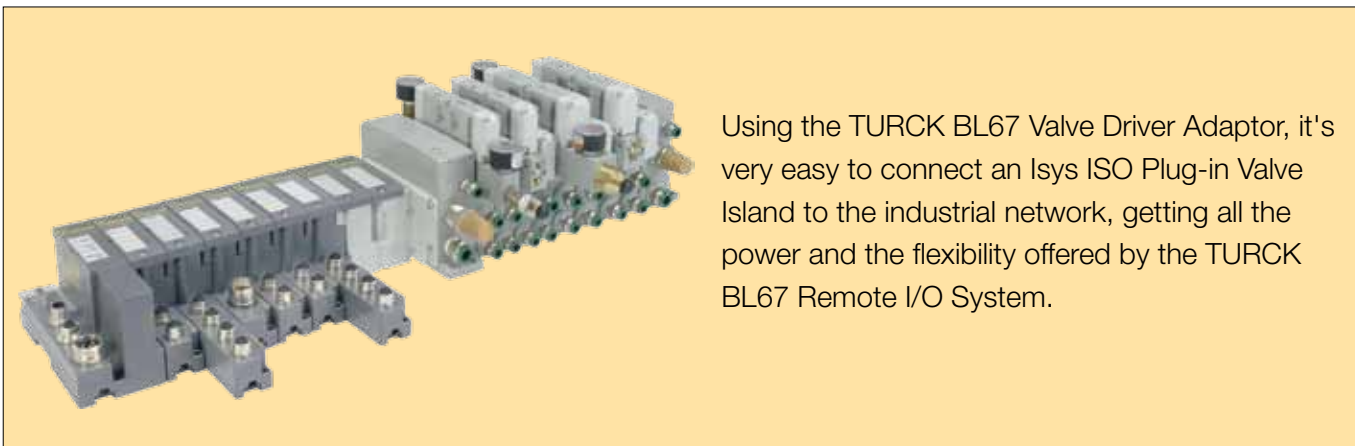

Using the TURCK BL67 Valve Driver Adaptor, it's very easy to connect an Isys ISO Plug-in Valve Island to the industrial network, getting all the power and the flexibility offered by the TURCK BL67 Remote I/O System.

Valve driver Module for 16 or 32 Outputs

Modularity up to 16 or 32 Outputs :

- Populated with 1 or 2 standard TURCK 16 Output modules BL67-16DO-0.1A-P, the Valve Driver Module can handle up to 16 or 32 solenoid valves.
- For a 16 Outputs configuration, the second slot has to be populated with 1 standard TURCK blank module BL67-E.



TURCK BL67 communication gateway

Industrial Communication :

- Linked to a TURCK BL67 communication module (programmable or not programmable), the device can be connected to a wide choice of Fieldbus or Industrial Ethernet protocols.



TURCK BL67 I/O and Base modules

The separation between electronic and base module for connectivity allows to complete the device with a choice through a full digital or analogue **I/O modules** range populating the **base module** existing with a multiple choice of electrical connection (M8, M12, M23)

The complete resulting configuration can handle :

- Up to 32 electrical modules (up to 2 in the Valve Driver Module)
- Up to 512 digital I/O (up to 32 outputs in the Valve Driver Module)
- Up to 128 analog I/O

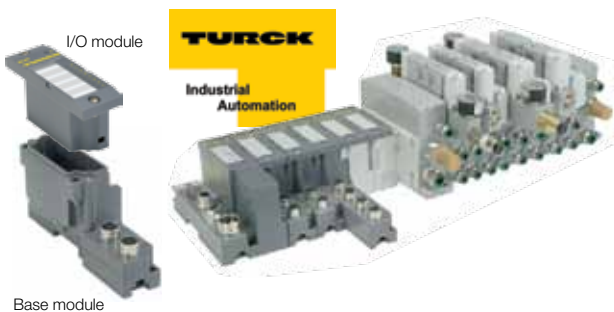

BL67 EtherNet/IP™ gateway to DeviceNet™

Using the TURCK BL67 EtherNet/IP™ gateway with DeviceNet™ master BL67-GW-EN-IP-DN, you can easily connect and configure a DeviceNet™ subnetwork thanks to the "SET-Button".



Full description of TURCK BL67 Series on <http://www.turck.com>

TURCK BL67 Communication Gateway

	Protocol	Network connection	Power Sup. Connection	Weight (g)	Order code
	CANopen (Bus IN & OUT)	M12 - A coding	7/8" - 5 Pin's	375	BL67-GW-CO
	DeviceNet™	7/8" - 5 Pin's	7/8" - 5 Pin's	360	BL67-GW-DN
	Profibus-DP (DPV0/DPV1)	M12 - B coding	7/8" - 5 Pin's	370	BL67-GW-DPV1
	Multiprotocol Ethernet: Modbus TCP, EtherNet/IP™ and PROFINET	M12 - D coding	7/8" - 5 Pin's	375	BL67-GW-EN
	Modbus TCP scan DeviceNet™	M12 - D coding	7/8" - 5 Pin's	375	BL67-GW-EN-DN
	Ethernet/IP™ scan DeviceNet™	M12 - D coding	7/8" - 5 Pin's	375	BL67-GW-EN-IP-DN

All TURCK BL67 System Modules can be ordered directly from TURCK under the same part number

TURCK BL67 Programmable Communication Gateway

	Protocol	Network connection	Power Sup. Connection	Weight (g)	Order code
	Profibus-DP	M12 - B coding	7/8" - 5 Pin's	380	BL67-PG-DP
	EtherNet/IP™	M12 - D coding	7/8" - 5 Pin's	375	BL67-PG-EN-IP
	Modbus TCP	M12 - D coding	7/8" - 5 Pin's	375	BL67-PG-EN

All TURCK BL67 System Modules can be ordered directly from TURCK under the same part number

TURCK BL67 Electronic Modules

	Description	Characteristic	Polarity	Weight (g)	Order code	
	Blank module			15	BL67-E	
	4 Digital Inputs			PNP	55	BL67-4DI-P
				NPN	55	BL67-4DI-N
	8 Digital Inputs		Channel diagnostics	PNP	55	BL67-4DI-PD
				PNP	55	BL67-8DI-P
				NPN	55	BL67-8DI-N
				PNP	55	BL67-8DI-PD
	16 Digital Inputs			PNP	55	BL67-16DI-P
	4 Digital Outputs	0.5 A		PNP	55	BL67-4DO-0.5A-P
				PNP	55	BL67-4DO-2A-P
				NPN	55	BL67-4DO-2A-N
				PNP	55	BL67-4DO-4A-P
	8 Digital Outputs	0.5 A		PNP	55	BL67-8DO-0.5A-P
				NPN	55	BL67-8DO-0.5A-N
	16 Digital Outputs	0.1 A		PNP	55	BL67-16DO-0.1A-P
	4 Digital Inputs & Outputs	0.5 A - Channel Diagnostic		PNP	55	BL67-4DI4DO-PD
	8 Configurable Digital Channels	0.5 A		PNP	55	BL67-8XSG-P
		0.5 A - Channel Diagnostics		PNP	55	BL67-8XSG-PD
	8 Isolated Relay Outputs	Normally open			55	BL67-8DO-R-NO
	2 analogue Inputs	16 bit resolution		Current	55	BL67-2AI-I
				Voltage	55	BL67-2AI-V
				For Pt and Ni sensors	55	BL67-2AI-PT
				For thermoelements	55	BL67-2AI-TC
	4 analogue Inputs	16 bit resolution		Current / Voltage	55	BL67-4AI-V/I
				For thermoelements	55	BL67-4AI-TC
	2 analogue Outputs	16 bit resolution		Current	55	BL67-2AO-I
				Voltage	55	BL67-2AO-V
	4 analogue Outputs	16 bit resolution		Voltage	55	BL67-4AO-V

All TURCK BL67 System Modules can be ordered directly from TURCK under the same part number

The complete TURCK BL67 Remote I/O System range on <http://www.turck.com> and <http://www.parker.com/pneu/fieldbus>

TURCK BL67 Base modules for Digital and Analog I/O Modules



Description	Connector Type	Con. Number	Weight (g)	Order code
Base Modules	M8, 3-pole, female	4	160	BL67-B-4M8
		8	215	BL67-B-8M8
	M8, 4-pole, female	8	215	BL67-B-8M8-4
	M12, 5-pole, female, A-coded	2	185	BL67-B-2M12
	M12, 5-pole, female, A-coded, paired	2	185	BL67-B-2M12-P
	M12, 5-pole, female, A-coded	4	245	BL67-B-4M12
	M12, 5-pole, female, A-coded, paired	4	245	BL67-B-4M12-P
	M23, 12-pole, female	1	190	BL67-B-1M23
	M23, 19-pole, female	1	190	BL67-B-1M23-19

All TURCK BL67 System Modules can be ordered directly from TURCK under the same part number

Electronic and Base Module Combinations

	BL67-B-4M8	BL67-B-8M8	BL67-B-2M12	BL67-B-2M12-P	BL67-B-4M12	BL67-B-4M12-P	BL67-B-1M23	BL67-B-1M23-19	BL67-B-8M8-4
Digital Input Modules									
BL67-4DI-P	✓		✓	✓	✓		✓		
BL67-4DI-N	✓		✓	✓	✓		✓		
BL67-4DI-PD	✓		✓	✓	✓				
BL67-8DI-P		✓			✓	✓	✓		
BL67-8DI-N		✓			✓	✓	✓		
BL67-8DI-PD		✓			✓	✓			
BL67-16DI-P							✓	✓	
Digital Output Modules									
BL67-4DO-0.5A-P	✓		✓	✓	✓		✓		
BL67-4DO-2A-P	✓		✓	✓	✓		✓		
BL67-4DO-2A-N	✓		✓	✓	✓		✓		
BL67-4DO-4A-P	✓		✓	✓	✓		✓		
BL67-8DO-0.5A-P		✓			✓	✓	✓		
BL67-8DO-0.5A-N		✓			✓	✓	✓		
BL67-16DO-0.1A-P							✓	✓	
BL67-4DI4DO-PD		✓			✓	✓			
Configurable Digital Input/Output Modules									
BL67-8XSG-P		✓			✓	✓			
BL67-8XSG-PD		✓			✓	✓			
Relay Output Module									
BL67-8DO-R-NO					✓				
Analogue Input Module									
BL67-2AI-I			✓						
BL67-2AI-V			✓						
BL67-2AI-PT			✓						
BL67-2AI-TC			✓						
BL67-4AI-V/I					✓				
BL67-4AI-TC					✓				
Analogue Output Module									
BL67-2AO-I			✓						
BL67-2AO-V			✓						
BL67-4AO-V					✓				

The complete TURCK BL67 Remote I/O System range on <http://www.turck.com>

TURCK BL67 Power Feeding and Base Modules

Description	Connector Type	Weight (g)	Order code
			Power Feeding Module for 24 VDC additional sourcing
Base Modules	1 x 7/8", 5-pole, male	VI / VO Sourcing	BL67-B-1RSM
		VO Sourcing	BL67-B-1RSM-VO
		1 x 7/8", 4-pole, male	55

All TURCK BL67 System Modules can be ordered directly from TURCK under the same part number

Power Feeding Base Modules Connection

Standard version

BL67-B-1RSM

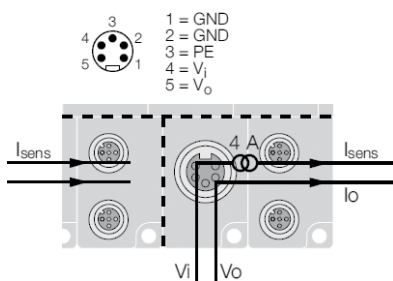

Other possible versions

BL67-B-1RSM-VO

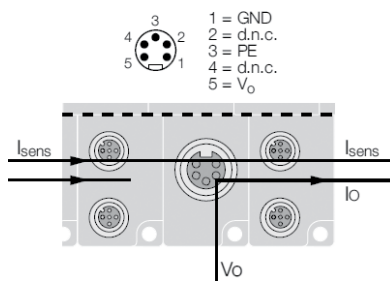

BL67-B-1RSM-4

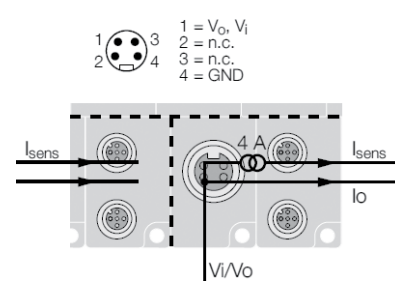

TURCK BL67 CANopen Gateway and Base Module

Description	Connector Type	Weight (g)	Order code
CANopen Gateway Module for CANopen Valve Island Interface		55	BL67-1CVI
Base Modules	1 x M12, 5-pole, female, A-coded	170	BL67-B-1M12

All TURCK BL67 System Modules can be ordered directly from TURCK under the same part number



BL67-1CVI electronic module with BL67-B-1M12

- Offering a CANopen Sub-Network connectivity up to 8 CANopen slaves

The complete TURCK BL67 Remote I/O System range on <http://www.turck.com>

Isysnet Fieldbus System

Modularity

- Ease of module replacement with unique latching mechanisms eliminating the need for screws.
- Auto Device Replacement allows OEMs to add I/O modules without making changes to the control software.
- Built-in panel grounding.
- Electronic and mechanical keying prevents users from placing I/O modules in the wrong sequence.

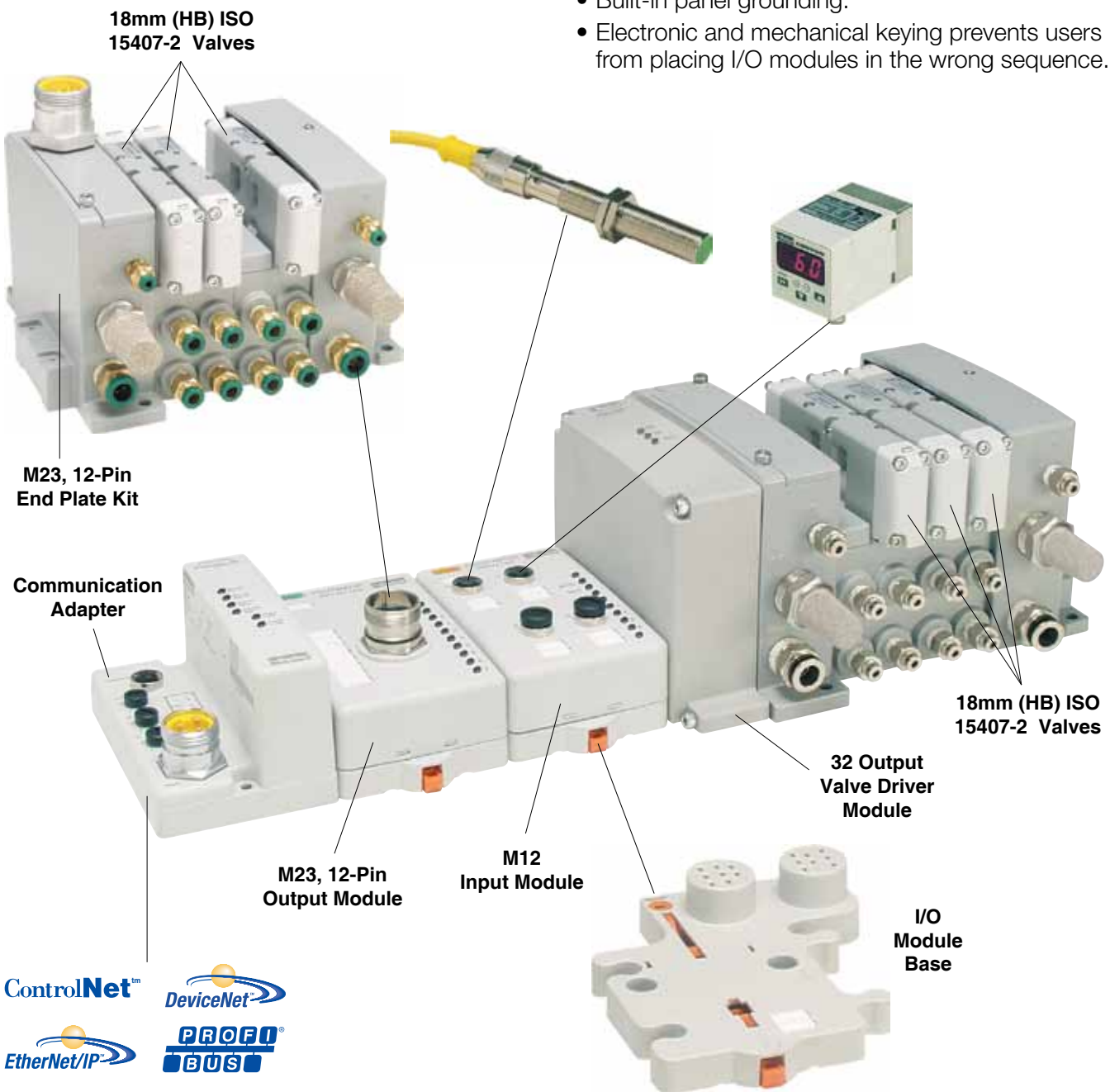

Communication Modules

- A Communication Module supports up to a maximum of 63 I/O modules and up to 264 Inputs and 264 Outputs.

Isysnet Fieldbus System

Integrated Solution

- A complete field bus communication offering for all ISO valves.
- Extremely fast I/O backplane uses change-of-state (COS) connections to maximize performance.
- UL, C-UL and CE certifications (as marked).

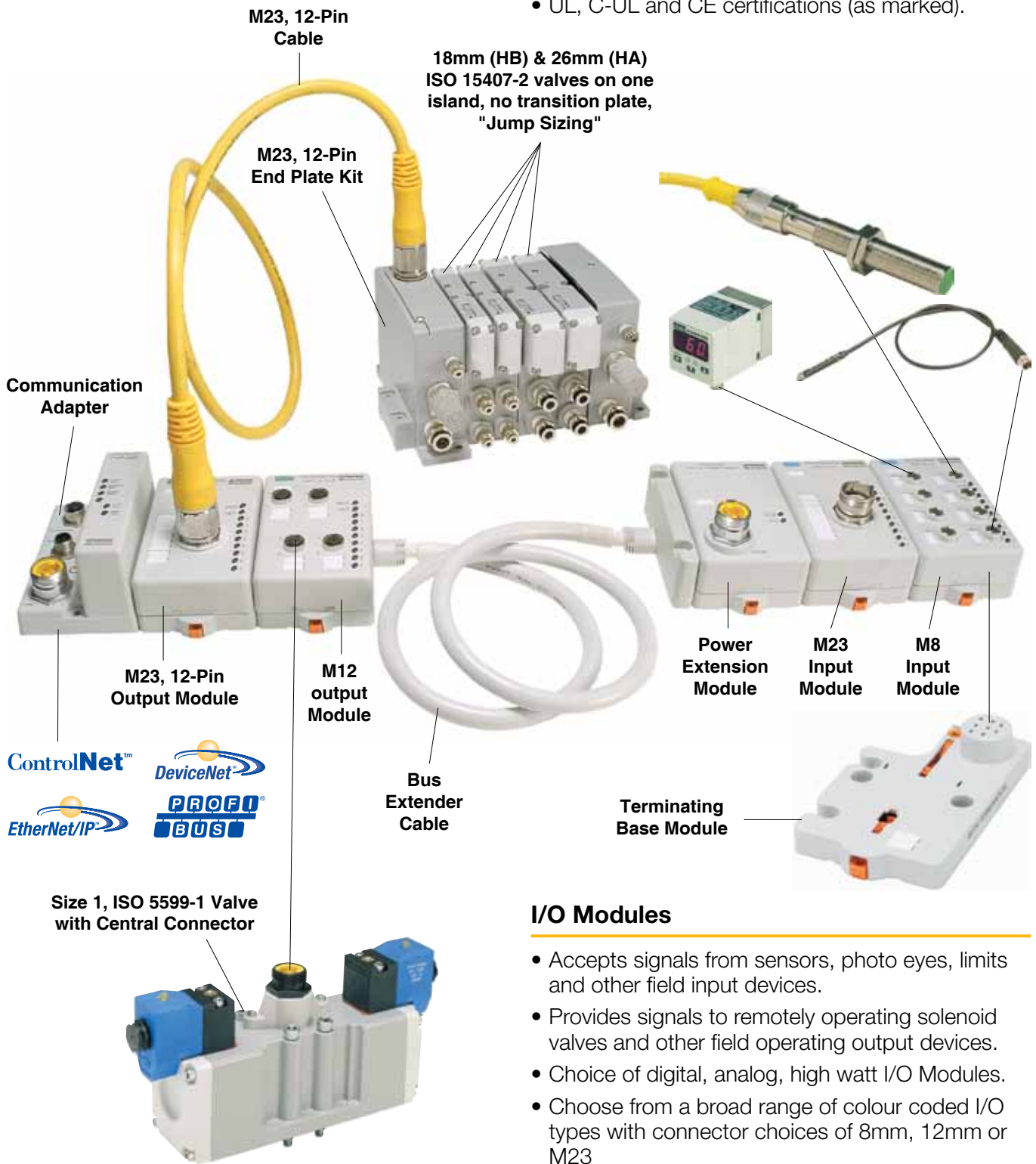

I/O Modules

- Accepts signals from sensors, photo eyes, limits and other field input devices.
- Provides signals to remotely operating solenoid valves and other field operating output devices.
- Choice of digital, analog, high watt I/O Modules.
- Choose from a broad range of colour coded I/O types with connector choices of 8mm, 12mm or M23
- Built-in miswiring, short circuit, open circuit detection with electronic feedback.

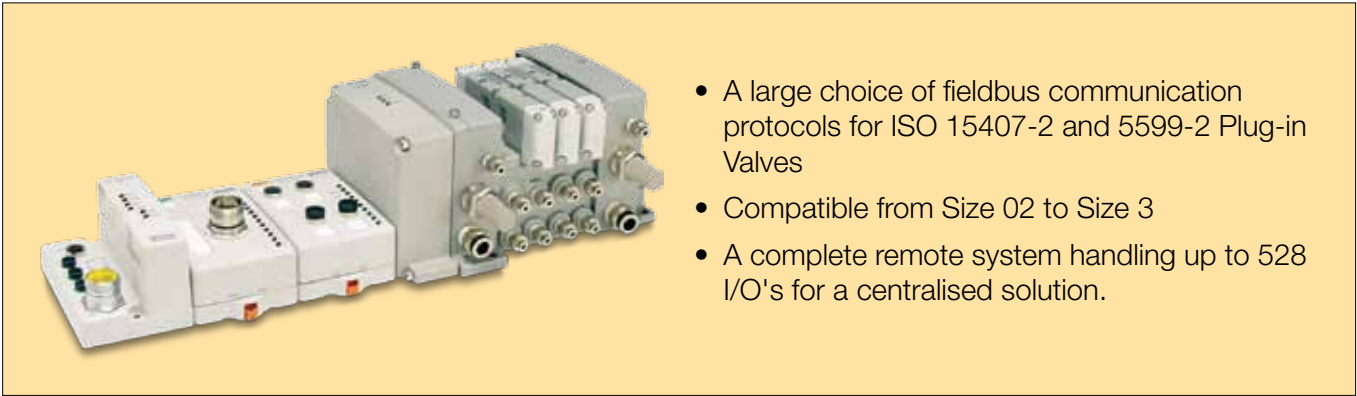

- A large choice of fieldbus communication protocols for ISO 15407-2 and 5599-2 Plug-in Valves
- Compatible from Size 02 to Size 3
- A complete remote system handling up to 528 I/O's for a centralised solution.

Isysnet Communication and I/O modules

Isysnet Communication modules

Isysnet communication modules are available in :

- DeviceNet™
- Profibus DP
- EtherNet/IP™
- ControlNet



Digital or Analogical electrical I/O modules

Some modules have diagnostic features, electronic fusing, or individually isolated inputs/outputs. The Isysnet family provides a wide range of input and output modules to span many applications, from highspeed discrete to process control. Isysnet supports producer/consumer technology, which allows input information and output status to be shared among multiple Logix controllers.



Isysnet Extension Power Unit

The auxiliary power supports up to 10 I/O modules and 32 output driver with a maximum of 10 A field power. The 24 VDC extension power unit (PSSSE24A) extends the backplane bus power to support up to 10 more I/O modules. Connect additional extension power units to expand the I/O assembly up to 63 I/O modules

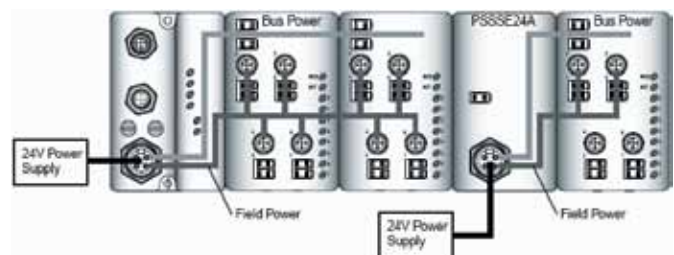

Technical data

Isysnet Communication modules & Extension power unit

Bus power supply :	24 VDC at 400 mA
Power supply input voltage :	24 VDC
Operative voltage range :	10 to 28.8 VDC
Input overvoltage protection :	Reverse polarity protected

Isysnet Analogue Input modules

Number of Outputs :	2
Input signal Range :	4 to 20 mA / 0 to 10 VDC
Pointbus current :	75 mA

Isysnet Analogue Output modules

Number of Outputs :	2
Input signal Range :	4 to 20 mA / 0 to 10 VDC
Pointbus current :	75 mA

Isysnet Digital Input modules

Number of Outputs :	8 – PNP or NPN
Operating Voltage Range :	10 to 28.8 VDC
Input current on-state :	2 to 5 mA
Input current off-state :	1,5 mA
Pointbus current :	75 mA

Isysnet Digital Output modules

Number of Outputs :	8
Operating Voltage Range :	10 to 28.8 VDC
Output current rating Max. :	1 A per channel 3 A per module
Pointbus current :	75 mA

Isysnet Relay Output modules







Number of Outputs :	4 – NO contacts
Operating Voltage Range :	5 to 28.8 VDC
Output current rating Max. :	2 A per channel 8 A per module
Pointbus current :	90 mA

Isysnet communication modules

	Description	Fieldbus connection	Power supply connector	Weight (g)	Order code
	DeviceNet™	M18	7/8" - 4 pins	400	PSSCDM18PA
		M12 - A coding	7/8" - 4 pins	400	PSSCDM12A
	Profibus-DP	M12 - B coding	7/8" - 5 pins	380	PSSCPBA
	EtherNet/IP™	M12 - D coding	7/8" - 4 pins	380	PSSCENA
	ControlNet	M12 - D coding	7/8" - 4 pins	380	PSSCCNA

For EDS and GSD files, go to <http://www.parker.com/pneu/isysnet>



Isysnet electrical I/O modules

	Description	Polarity	Connector type	Weight (g)	Order code
	8 Digital Inputs	PNP	8 x M8	400	PSSN8M8A
			4 x M12	380	PSSN8M12A
	8 Digital Inputs	NPN	8 x M8	400	PSSP8M8A
			4 x M12	380	PSSP8M12A
	8 Digital Outputs	PNP	8 x M8	400	PSST8M8A
			4 x M12	380	PSST8M12A
	4 Digital Outputs	Relay	4 x M12	410	PSSTR4M12A
	2 Analogue Inputs	0 - 10 V	2 x M12	400	PSSNAVM12A
		4 - 20 mA	2 x M12	400	PSSNACM12A
	2 Analogue Outputs	0 - 10 V	2x M12	400	PSSTAVM12A
		4 - 20 mA	2 x M12	400	PSSTACM12A



Isysnet auxiliary electrical modules

	Description	Connector type	Weight (g)	Order code
	24 VDC expansion power unit	7/8" - 4 pins	420	PSSSE24A

Isysnet bus extender

	Description	Length	Weight (g)	Order code
	Bus extender cable for Isysnet module interconnection	1 meter	380	PSSEXT1
		3 meters	760	PSSEXT3
	Isysnet termination module		200	PSSTERM

Isysnet accessories

	Description	Bus protocol	Connector type	Weight (g)	Order code
	Power supply connector	DeviceNet™, ControlNet™ & EtherNet/IP™	7/8" - 4 pins	40	P8CS7804AA
		Profibus-DP	7/8" - 5 pins	40	P8CS7805AA
	Line termination	DeviceNet™	M12 - A coding	25	P8BPA00MA
		Profibus-DP	M12 - B coding	25	P8BPA00MB
	Bus IN female connector	DeviceNet™	M12 - A coding	25	P8CS1205AA
		Profibus-DP	M12 - B coding	25	P8CS1205AB
	Bus OUT male connector	DeviceNet™	M12 - A coding	25	P8CS1205BA
		Profibus-DP	M12 - B coding	25	P8CS1205BB
	Cable quick connect connector		M8	25	P8CS0803J
			M12 - A coding	25	P8CS1204J
	"Y" shape, thread to thread		M12 - 2 x M12	25	P8CSY1212A

Moduflex Bus System

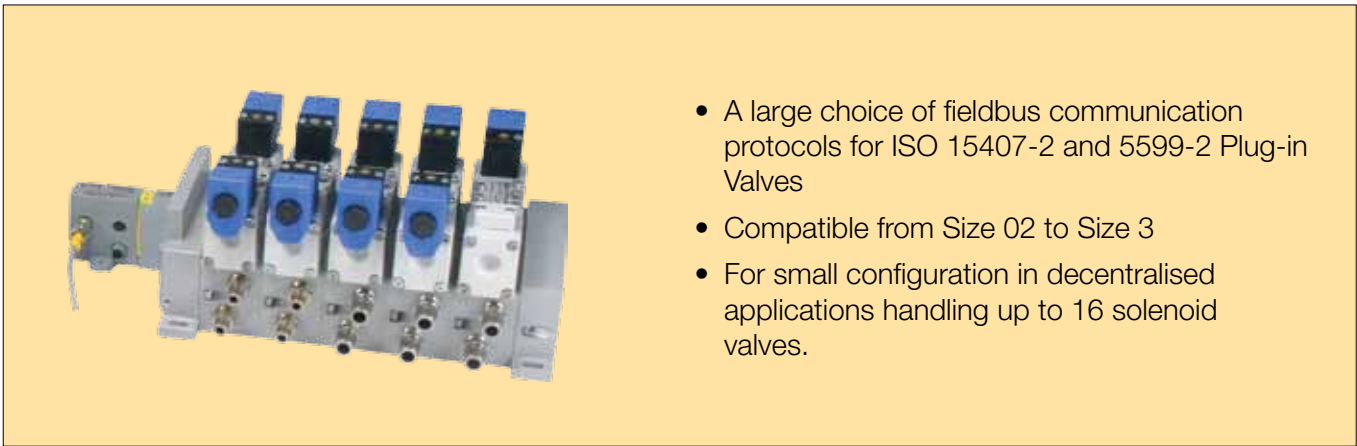

- A large choice of fieldbus communication protocols for ISO 15407-2 and 5599-2 Plug-in Valves
- Compatible from Size 02 to Size 3
- For small configuration in decentralised applications handling up to 16 solenoid valves.

Moduflex Bus 16 Outputs

Communication module handling up to 16 solenoids and available in Profibus DP, DeviceNet™, CANopen, InterBus-S and AS-interface protocols



Closer to the cylinder

Decentralised application when solenoid valves have to be closer to the pneumatic actuators.



DeviceNet gateway

Compatible with the TURCK BL67 EtherNet/IP™ gateway with Master DeviceNet™ **BL67-GW-IP-DN**

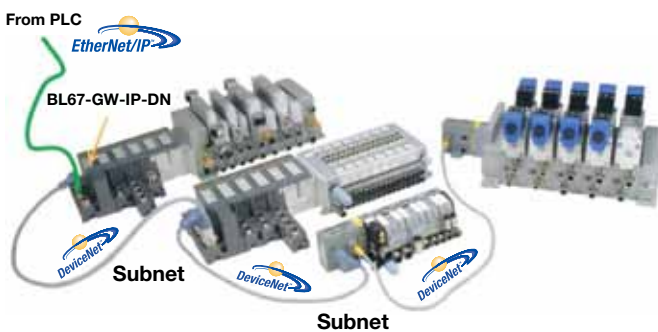

CANopen gateway

Compatible with the TURCK BL67 CANopen sub-network module **BL67-1CVI** connected to the base module **BL67-B-1M12**

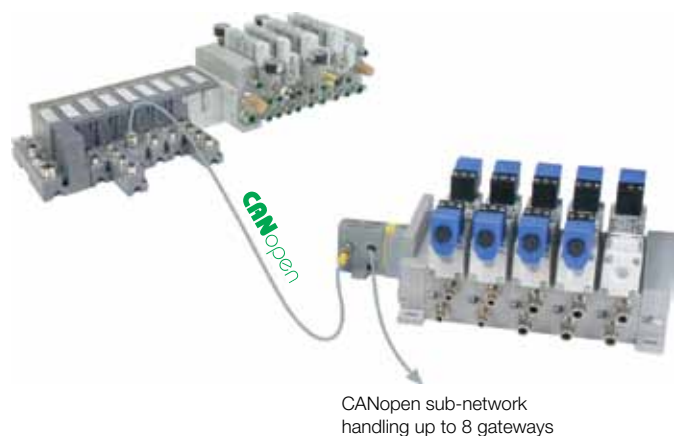

Moduflex Bus Communication Gateway for device bus protocols

Communication module for configuration up to 16 solenoid valves

	Protocol	Network connection	Power Sup. Connection	Weight (g)	Order code
	Profibus-DP	M12 - B coding	M12 - A coding	250	P2M2HBVP21600
	DeviceNet™	M12 - A coding	M12 - A coding	250	P2M2HBVD21600
			M12 - B coding	250	P2M2HBVD11600
	CANOpen	M12 - A coding	M12 - A coding	250	P2M2HBVC21600
			M12 - B coding	250	P2M2HBVC11600
InterBus-S	M23 - 9 Pin's	M12 - A coding	300	P2M2HBVS11600	

For EDS and GSD files, go to <http://www.parker.com/pneu/moduflex>

Device Bus connection accessories

	Description	Bus Protocol	Connector type	Weight (g)	Order code
	Power supply female straight connector	All	M12 - A coding	25	P8CS1205AA
			M12 - B coding	25	P8CS1205AB
	Bus IN female connector	DeviceNet™ CANopen	M12 - A coding	25	P8CS1205AA
			Profibus-DP	M12 - B coding	25
	Bus OUT male connector	DeviceNet™ CANopen	M12 - A coding	25	P8CS1205BA
			Profibus-DP	M12 - B coding	25
	Line termination	DeviceNet™ CANopen	M12 - A coding	25	P8BPA00MA
			Profibus-DP	M12 - B coding	25

Moduflex Bus Communication Gateway for AS-interface protocol

	Description	No outputs / node add.	Input connections Connection	Weight (g)	Order code
	Standard AS-i protocol (Up to 31 nodes)	8 Outputs / 2 addresses	No. input	150	P2M2HBVA10800
			8 M8 inputs	200	P2M2HBVA10808A
			8 inputs on 4 M12	200	P2M2HBVA10808B
	Extended AS-i protocol (Up to 62 nodes - A/B coding)	6 Outputs / 2 addresses	No. input	150	P2M2HBVA10400
			4 inputs on 4 M12	200	P2M2HBVA10404B
			8 M8 inputs	200	P2M2HBVA20808A
		8 inputs on 4 M12	200	P2M2HBVA20808B	

AS-i head module accessories

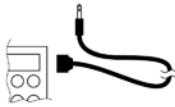
	Description	Connector type	Weight (g)	Order code
	Cable quick connect connector	M8 Male	25	P8CS0803J
		M12 Male - A coding	25	P8CS1204J
	« Y » shape	M12 Male - 2 x M12 Female	25	P8CSY1212A
	Addressing cable 1 meter	M12 Male - Jack	100	P8LS12JACK

ISOMAX - ISO 15407-1 - Sizes 02 & 01

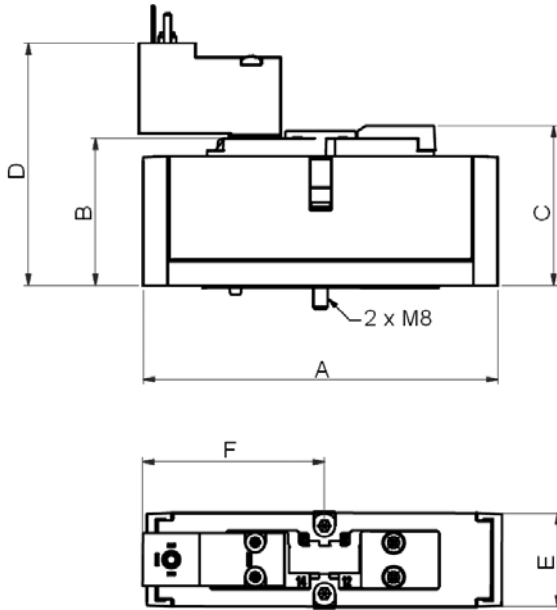

	A	B	C	D	E	F
ISOMAX 02	80	41	44,5	67,8	18	51,2
ISOMAX 01	100	42	45,5	68,8	26	51,2

ISOMAX - ISO 5599-1 - Sizes 1, 2 & 3

With P2F operator

With EV30 operator

With EV310 operator

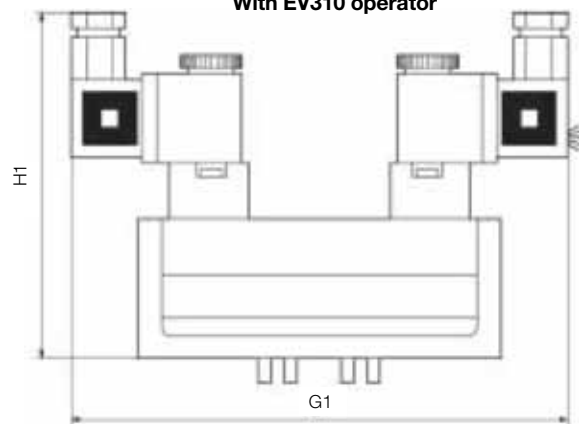
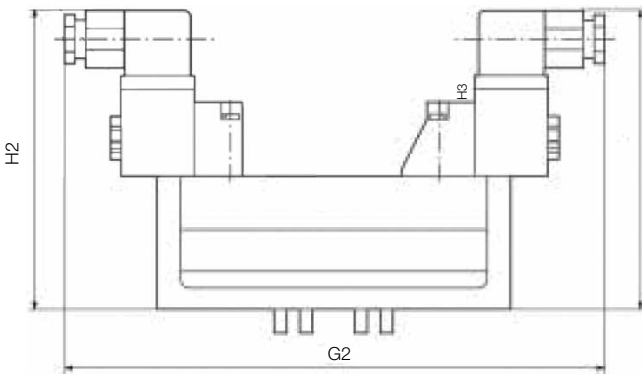

Pneumatically actuated

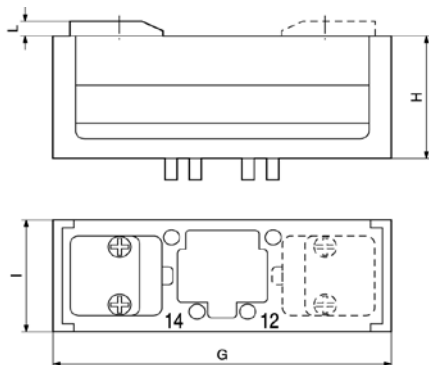

	G	G1	G2	H	H1	H2	I	L
Size 1	120	164	202,5	47	115	119	42	5
Size 2	140	179,5	218	58,5	126,5	130	54	5
Size 3	170	198	235,5	71	139	142,5	68	5

15 mm DIN Form C solenoid operators and connectors

P2E Operator

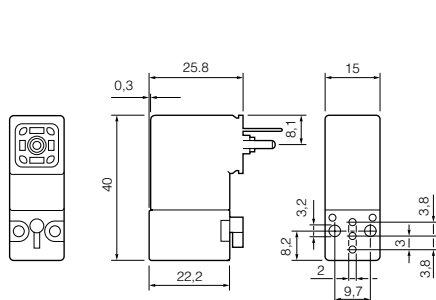

Connector with standard screw

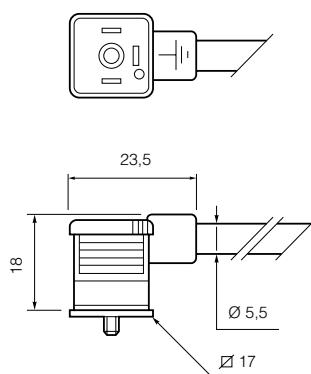

Connector with large headed screw

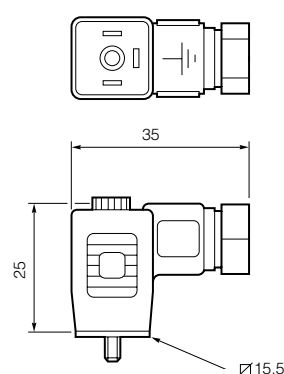

CNOMO 22 x 30 solenoid operators and connectors

P2F Operator with 30 x 30 DIN form A coil

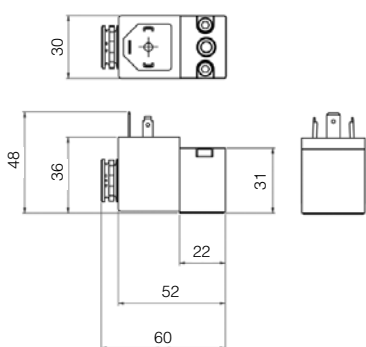

EV30 Operator with 30 x 30 DIN form A coil

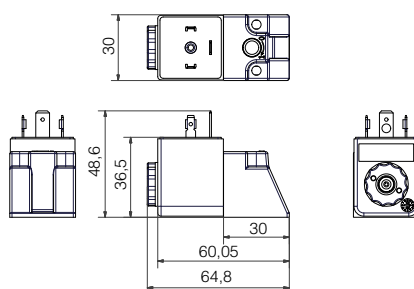

30 x 30 DIN form A connector

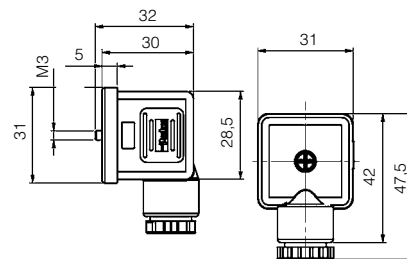

EV310 Operator with 22 x 30 DIN form B coil

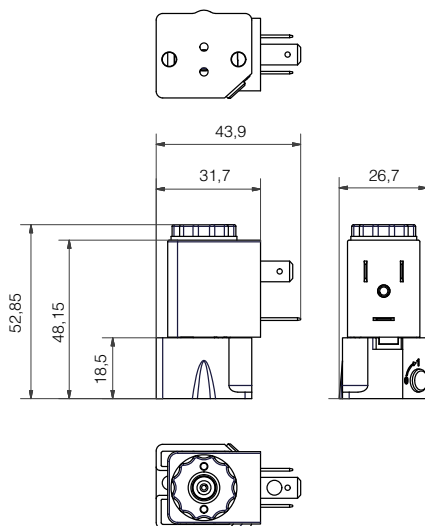

22 x 30 DIN form B connector

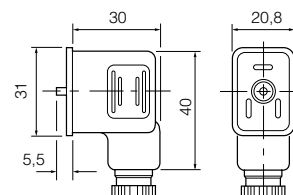

Side ported individual subbase - ISO 15407-1 - Sizes 02 & 01

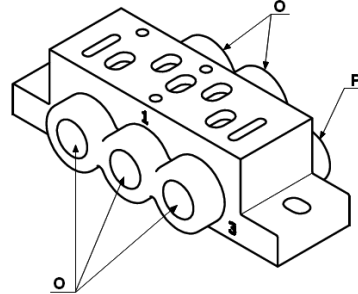
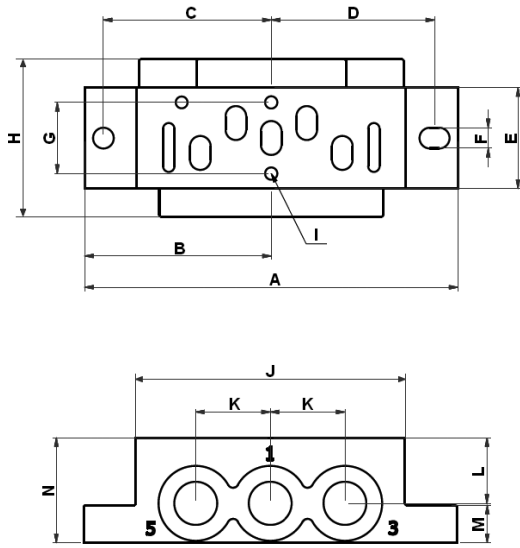

		Size	A	B	C	D	E	F	G	H	I	J	K	L	M	N	O	P
PL02-01-70	BSPP	02	80	40	35	33.75	19	5.5	12.5	27	M8	50	16	14	8	22.5	1/8	1/8
PL02-01-80	NPT	02	80	40	35	33.75	19	5.5	12.5	27	M8	50	16	14	8	22.5	1/8	1/8
PL01-02-70	BSPP	01	100	50	45	43.75	27	5.5	19	42,5	M8	72	20	17,5	10	28	1/4	1/8
PL01-02-80	NPT	01	100	50	45	43.75	27	5.5	19	42,5	M8	72	20	17,5	10	28	1/4	1/8

Front ported manifold & End plate - ISO 15407-1 - Sizes 02 & 01

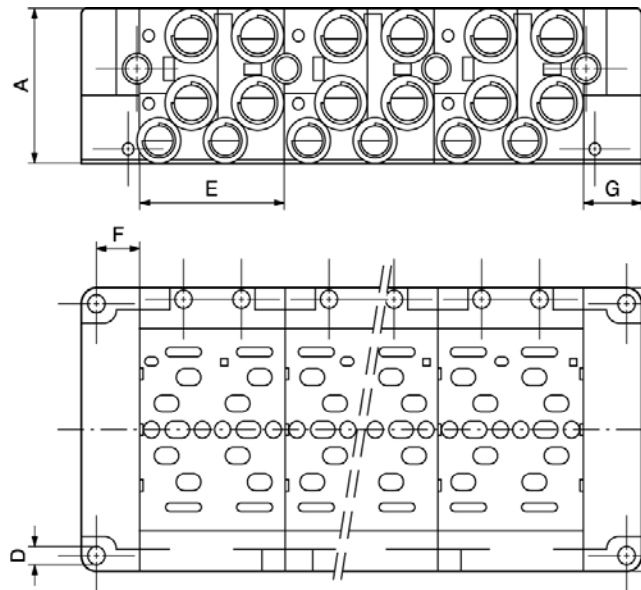

		Size	A	B	C	D	E	F	G	H
PJLP02-201-70	BSPP	02	38,5	80	-	-	38	-	-	-
PJLP02-201-80	NPT	02	38,5	80	-	-	38	-	-	-
PJLP01-202-70	BSPP	01	55	100	-	-	54	-	-	-
PJLP01-202-80	NPT	01	55	100	-	-	54	-	-	-
PJL01-202-70	BSPP	01	55	100	-	-	54	-	-	-
PJL01-202-80	NPT	01	55	100	-	-	54	-	-	-
PEJ02-02-70	BSPP	02	38,5	80	12	Ø4,2	-	14	18	70
PEJ02-02-80	NPT	02	38,5	80	12	Ø4,2	-	14	18	70
PEJ01-03-70	BSPP	01	55	100	24	Ø5,5	-	17	22	90
PEJ01-03-80	NPT	01	55	100	24	Ø5,5	-	17	22	90

PJLP01-201-70
PJLP01-202-70

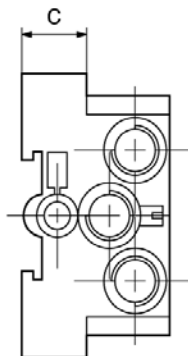

Bottom ported manifold - ISO 15407-1 - Sizes 02 & 01

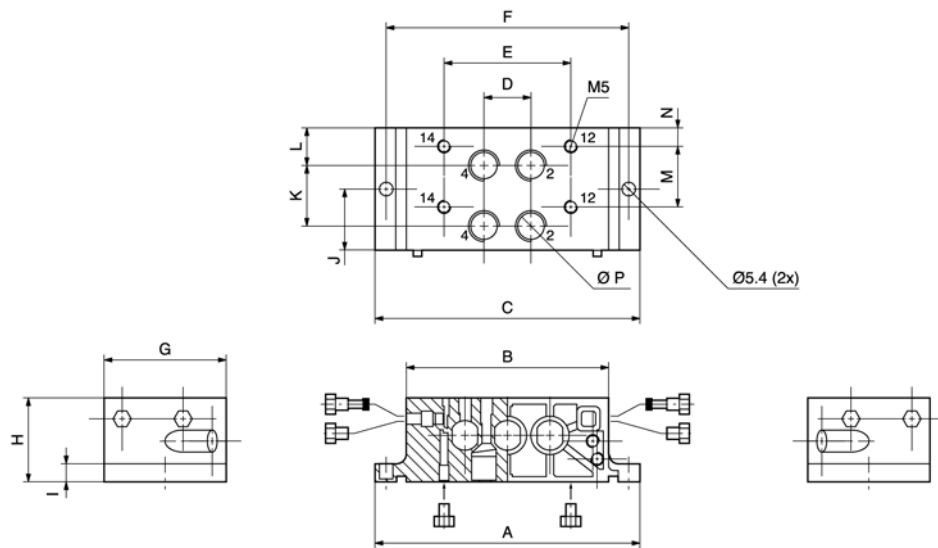

	Size	A	B	C	D	E	F	G	H	I	J	K	L	M	N	P
P2V-AM511PB	02	102	74	74,6	16	43	92	38	26	7	19	19	11	19	5	G1/8
P2V-BM512PB	01	118	90	90,6	21	56,5	108	54	37	8	27	27	16,5	27	8	G1/4

Bottom ported End plate - ISO 15407-1 - Sizes 02 & 01

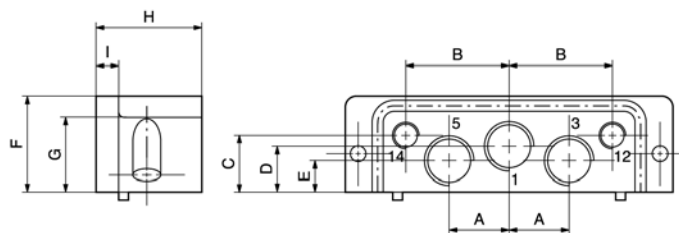

	Size	Port size 1,2,3	Port size 12, 14	A	B	C	D	E	F	G	H	I
P2V-AM512XX and P2V-AM512XX	02	G1/4	G1/8	17	29	21	18,5	9,5	35,5	28	33	7
P2V-BM513XX and P2V-BM513XX	01	G3/8	G1/8	21,5	37	20	16	11	34,5	28	38	8

Transfer plate size 01 to size 02 for above bottom ported manifold

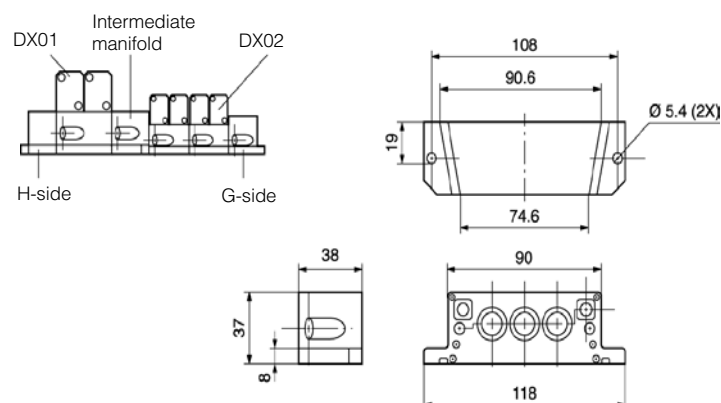

ISO 5599-1 Subbase & Manifolds

VDMA Side Ported Subbases

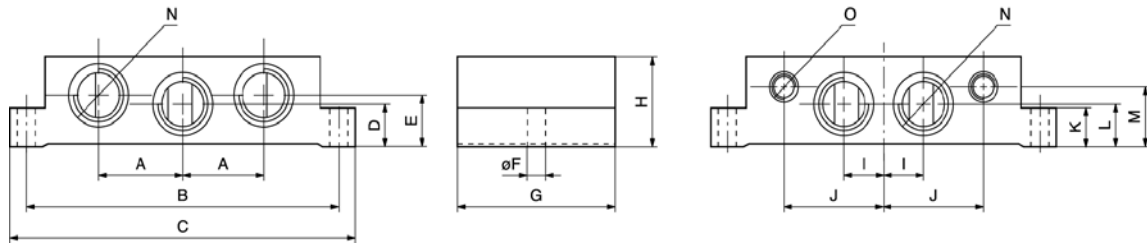

Order code	ISO Size	Port Size	A	B	C	D	E	F	G	H	I	J	K	L	M	N	O
P2N-VS512SD	1	G1/4	21,5	98	110	11	20	5,5	48	32	12	29	10	11	23	G1/4	G1/8
P2N-WS513SD	2	G3/8	28	112	124	14	26	6,6	56	40	15	37	13	14	30	G3/8	G1/8
P2N-YS514SD	3	G1/2	34	136	149	17	17	6,6	71	32	16	45	18	17	22	G1/2	G1/8

VDMA Bottom Ported Manifold

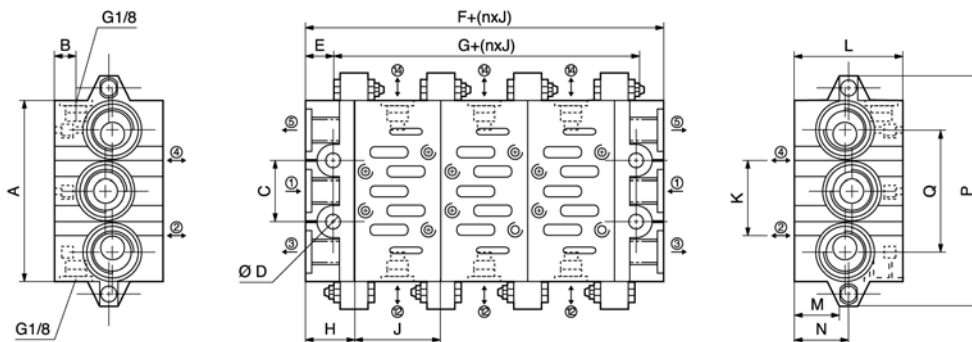

Order code	ISO Size	Port 1, 3, 5	Port 2, 4	A	B	C	D	E	F	G	H	J	K	L	M	N	O	P
P2N-VM512MB	1	G3/8	G1/4	85	8,5	28	7	11	44	22	22	43	26	46	21	24	56	110
P2N-WM513MB	2	G1/2	G3/8	100	9	35	9	13	52	26	26	56	30	47	22	24	68	135
P2N-YM514MB	3	G1	G1/2	140	10	52	12	15	60	30	30	71	38	56	31	34	104	190

Side ported subbases

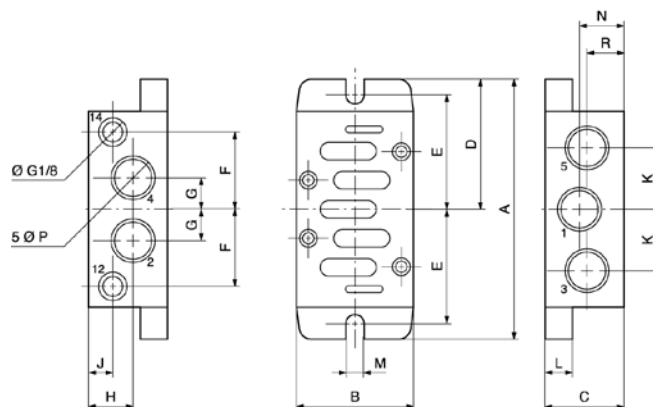

Order code	ISO Size	ØP	A	B	C	D	E	F	G	H	J	K	L	M	N	R
PL1-1/4-70	1	G1/4	110	46	29	55	49	30	11	17,75	17,75	22	6	5,5	17,75	17,75
PL2-3/8-70	2	G3/8	124	56	37	62	55	37	14,5	22,5	14	28	6	5,5	22,5	14,5
P2N-JS516SD	3	G3/4	149	71	60	74,5	68	45	21	33	10	40	18	6,6	37,5	22,5

Bottom ported subbases

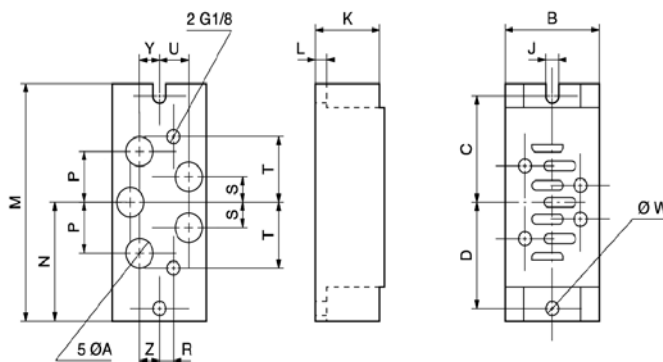

Order code	ISO Size	A	B	C	D	J	K	L	M	N	P	R	S	T	U	W	Y	Z
PD1-1/4-70	1	G1/4	46	49	49	5,5	29	6	110	55	22	10	11	30	10	5,5	10	10
PD2-3/8-70	2	G3/8	56	55	55	5,5	37	6	124	62	29	10	14,5	37	12,5	5,5	12,5	12,5
PD3-1/2-70	3	G1/2	77	68	68	6,6	32	18	149	74,5	34	10	17	45	17	6,5	17	17

Size 1 bottom ported manifold

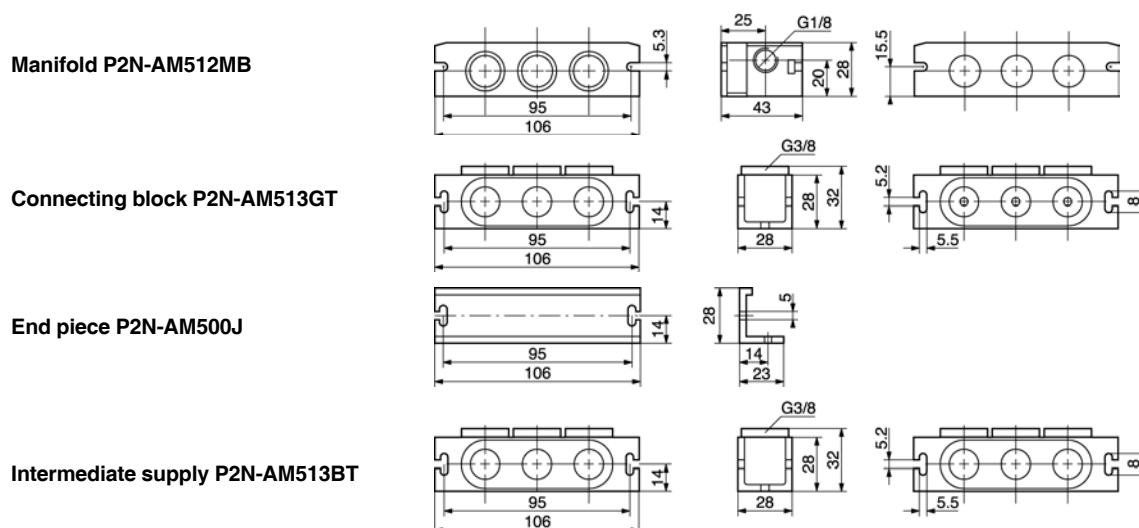

Sizes 1 & 2 side ported manifold

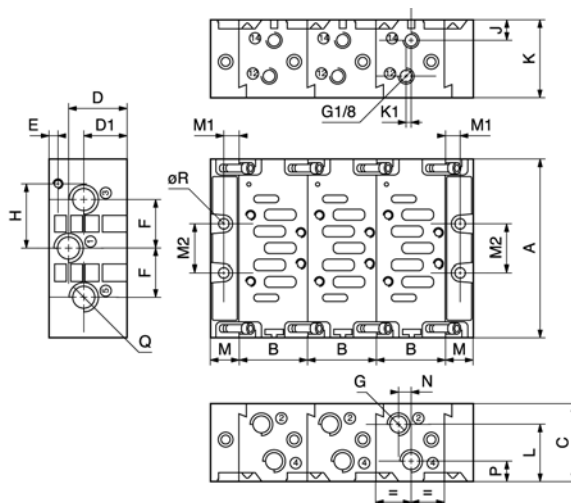

Order code	A	B	C	D	D1	E	F	G	H	J	K	K1	L	M	M1	M2	N	P	Q	R
P2N-EM ...	110	43	48	35,5	26,5	5,5	28	G1/4	36	15,5	35	3	32	20	11	28	12	12,5	G3/8	6
P2N-FM ...	129	56	60	44,5	35,5	6	34,5	G3/8	45	16	41,5	3	41	24	13	35	12,5	16	G1/2	8

Isys ISO Valves

HA / HB Series - ISO 15407-1

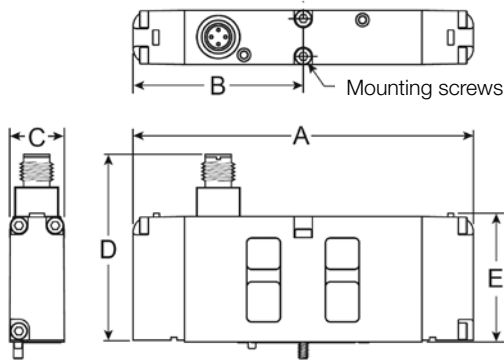

	A	B	C	D	E
HB	113	56	18	61	43
HA	130	65	26	61	42

HA / HB Series - ISO 15407-2

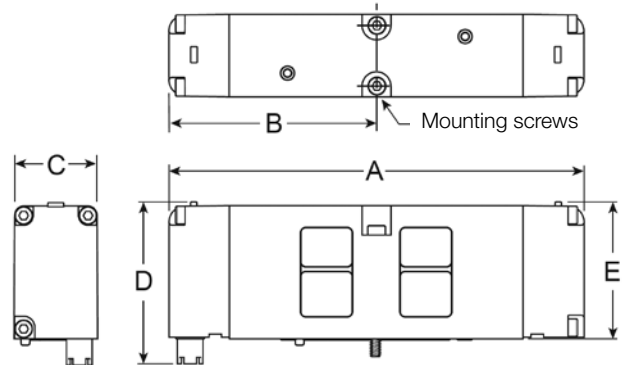

	A	B	C	D	E
HB	113	56	18	50	43
HA	130	65	26	50	42

H1 / H2 / H3 Series - ISO 5599-1

CNOMO Operator or Remote Pilot

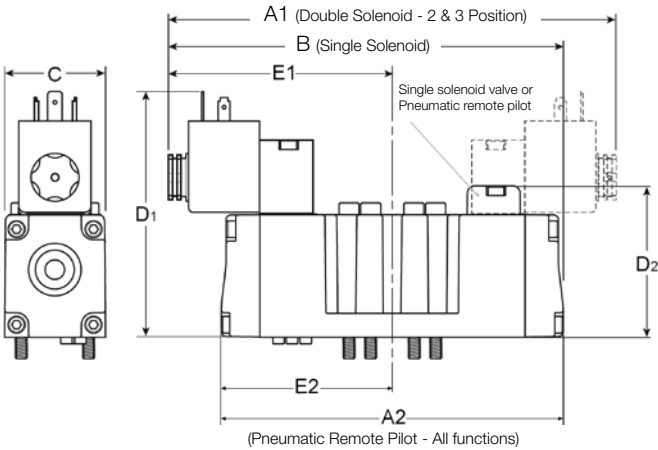

	A1	A2	B	C	D1	D2	E1	E2
H1	186	142	164	42	109	63,5	93	71
H2	212	168	190	55	122	76	106	84
H3	241	177	209	55	122	76	121	89

H1 / H2 / H3 Series - ISO 5599-2

Plug-in and M12 Connector Versions

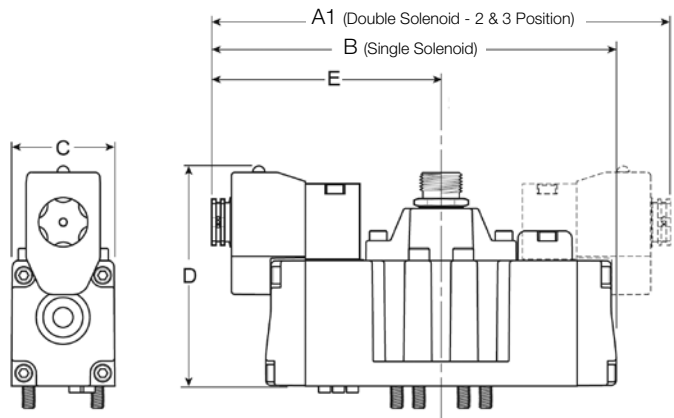

	A	B	C	D	E
H1	186	164	42	90	93
H2	212	190	55	103	106
H3	241	209	55	103	121

Isys ISO Subbases

HA Series - ISO 15407-1 & -2

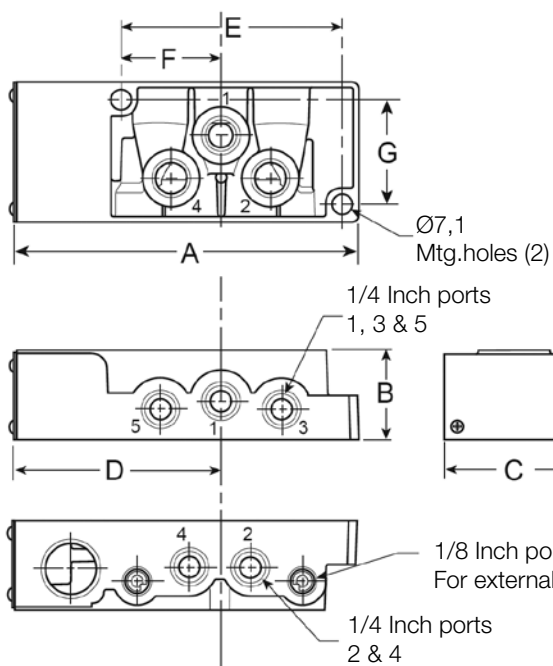

	A	B	C	D	E	F	G
HA	124	32,5	50,8	74	36,2	80,2	37,9

H1 / H2 / H3 Series - ISO 5599-1 & -2

Side Ported Subbase

Bottom Ported Subbase

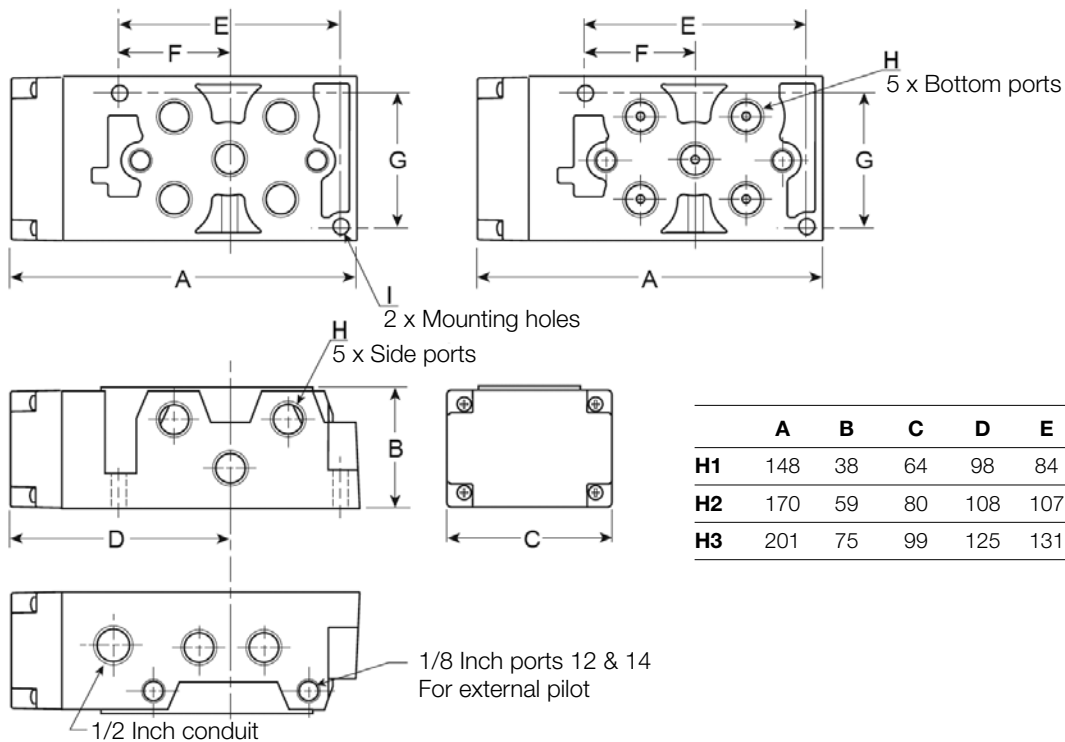

	A	B	C	D	E	F	G	H	I
H1	148	38	64	98	84	40	51	3/8"	5,5
H2	170	59	80	108	107	52	65	1/2"	7,1
H3	201	75	99	125	131	64	82	3/4"	9

Isys ISO Manifolds

HA/HB Series - ISO 15407-2

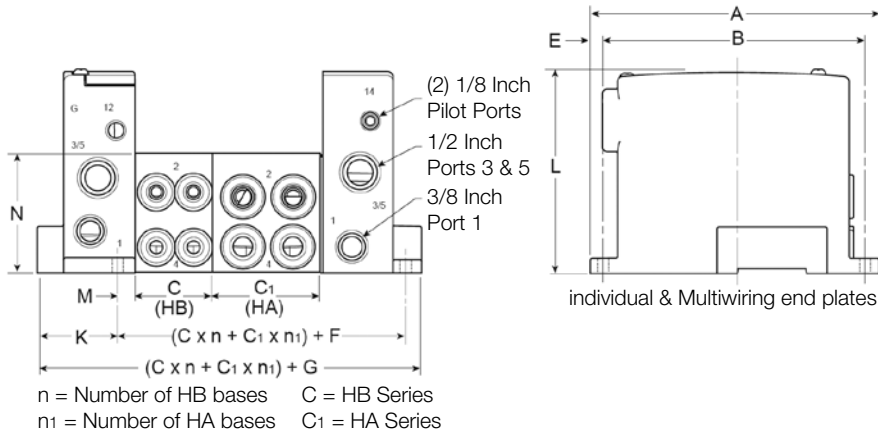

	A	B	C	C1	D	E	F
HA/HB	152	137	40,8	56,8	16	7,5	54,4
	G	H	J	K	L	M	N
HA/HB	104,6	109,8	4	42,7	106	8,4	63

H1 / H2 / H3 Series - ISO 5599-2

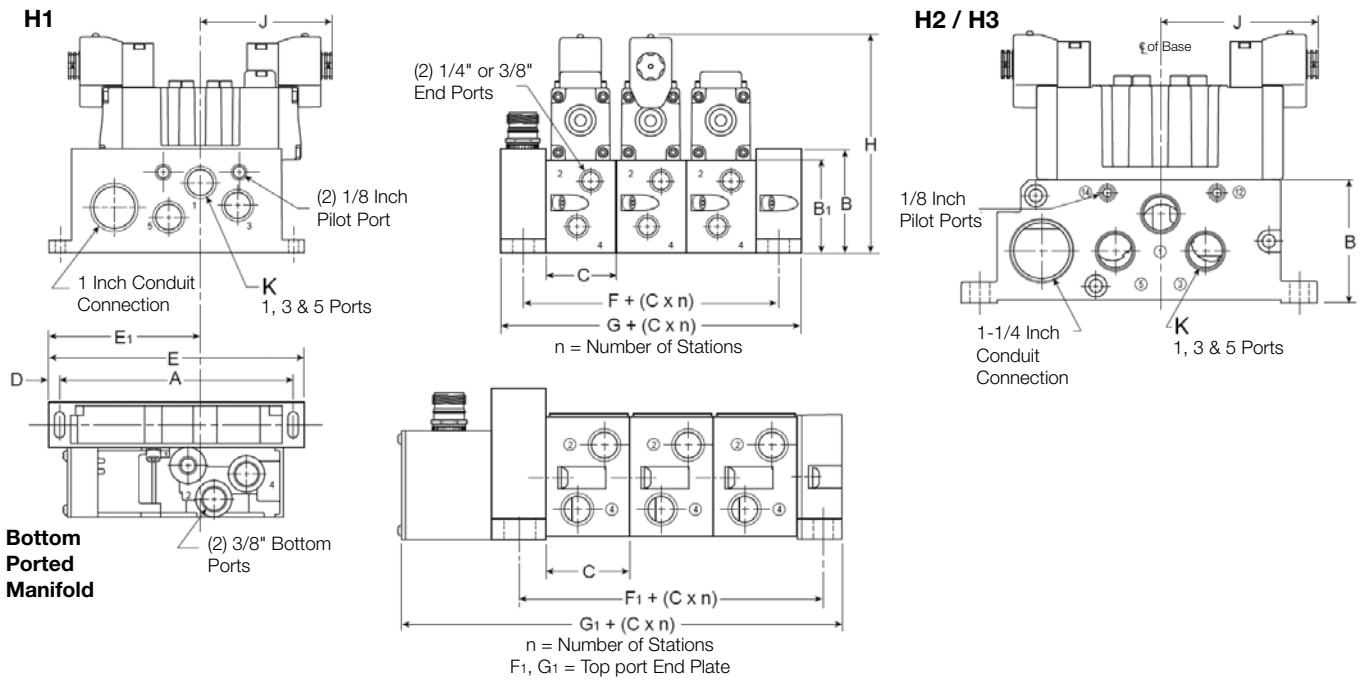

	A	B	B1	C	D	E	E1	F	F1	G	G1	H	J	K
H1	165	73	67	50	8	182	108	32	-	63,5	86	157	93	1/2"
H2	215	85	-	56	12	239	134	30	33	60	96	188	106	3/4"
H2	265	105	-	71	15	295	159	33	41	63	111	208	-	1"

Isys ISO 15407-2 & 5599-2 Sizes 02 to 3 with Turck BL67 Remote IO System

HA/HB Series

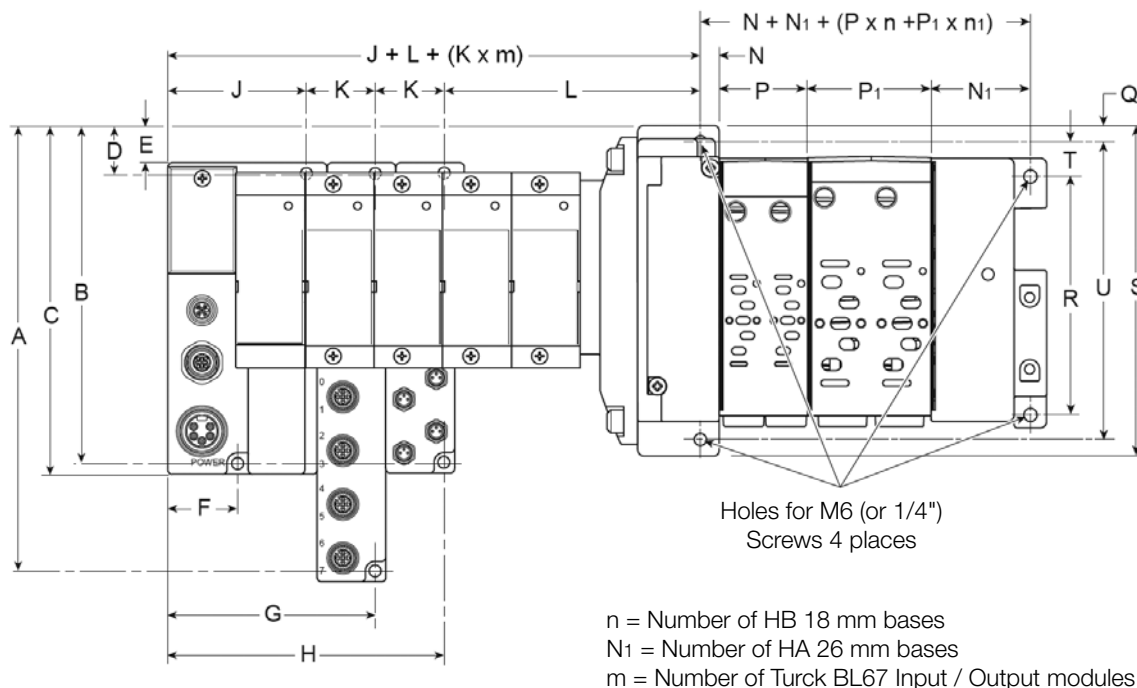

H1/H2/H3 Series

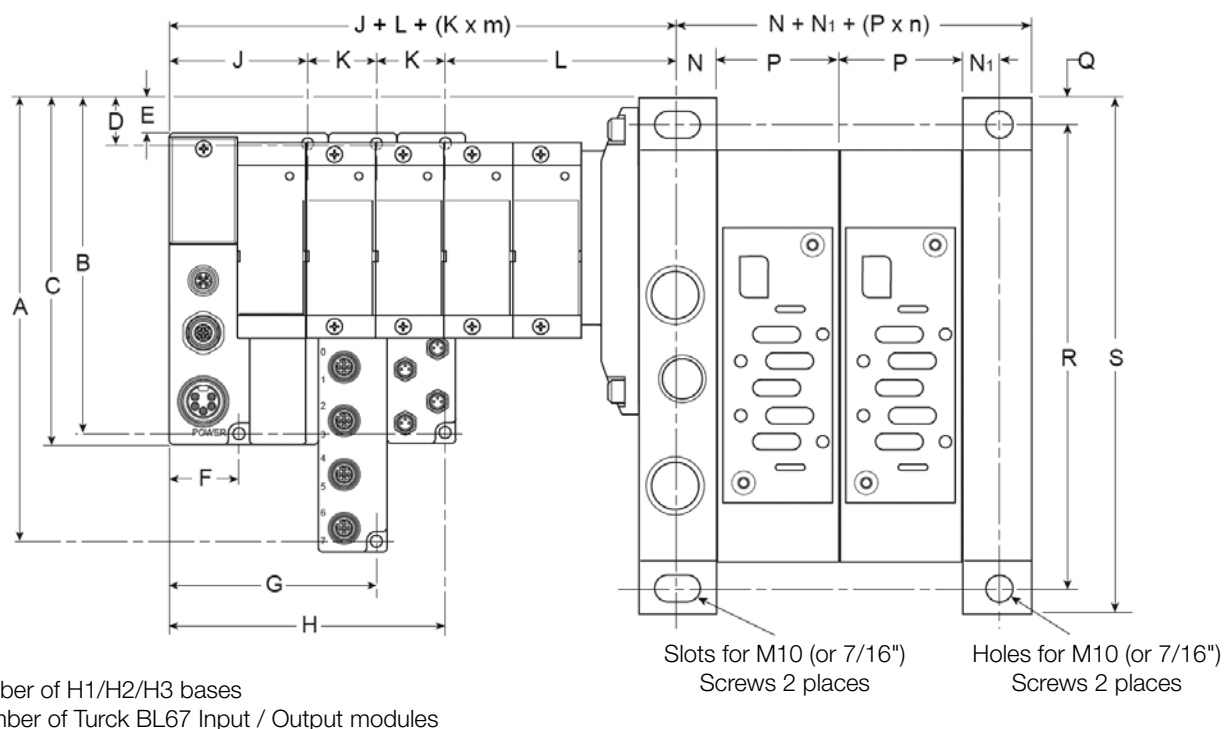

	A	B	C	D	E	F	G	H	J	K	L	N	N ₁	P	P ₁	Q	R	S	T	U
HA/HB	204,5	154,5	159,5	19,5	14,5	32,5	96,5	128,5	64,5	32	120,8	8,4	45,8	40,8	56,8	4	110	152	16	137
H1	216,7	166,7	171,7	31,7	26,7	32,5	96,5	128,5	64,5	32	108,5	15,9	15,9	49	-	8,5	165	182	-	-
H2	212,9	162,9	167,9	27,9	22,9	32,5	96,5	128,5	64,5	32	108,6	18	15	56	-	12	215	239	-	-
H3	218,9	168,9	173,9	33,9	28,9	32,5	96,5	128,5	64,5	32	116,6	24	16,5	71	-	15	265	295	-	-

Isys ISO 15407-2 & 5599-2 Sizes 02 to 3 with Isysnet Fieldbus System

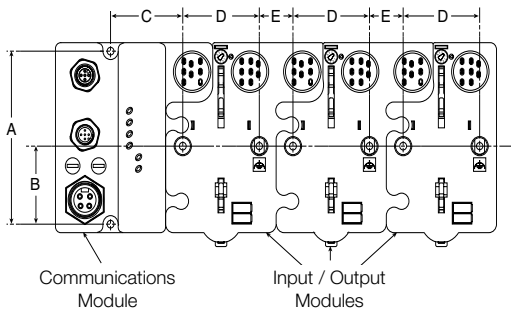

HA / HB Dimensions

	A	B	C	D	E	F
HA/HB	102	46	48	51	22	11

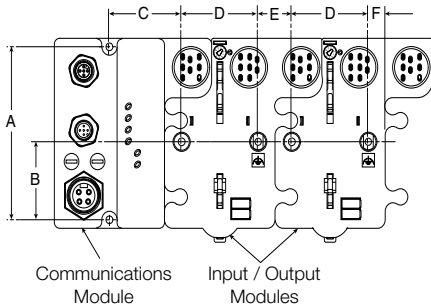

n = Number of 18mm HB bases
 N1 = Number of 26mm HA bases
 W = Width of 18mm HB bases
 W1 = Width of 26mm HA bases

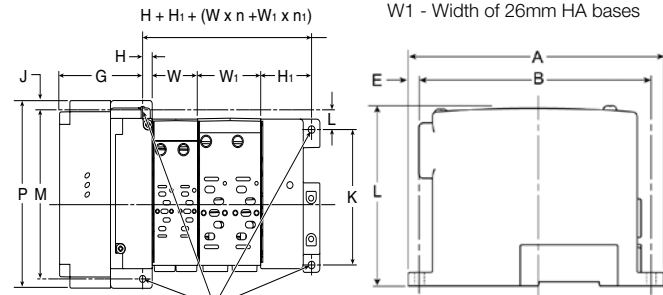

Holes for M6 (or 1/4")
 Screws 4 places

	A	B	E	L	G	H	H ₁
HA/HB	152	137	7,5	106	68	8,4	45,8
	J	K	L	M	P	W	W ₁
HA/HB	4	110	16	137	152	40,8	56,8

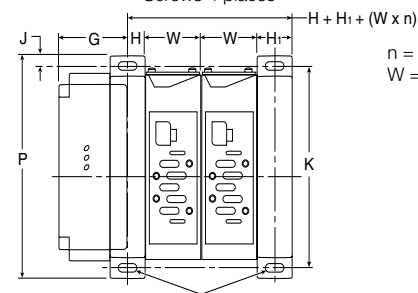

Slots for M6 (or 1/4")
 Screws 4 places

n = Number of H1 bases
 W = Width of H1 bases

	G	H	H ₁	J	K	P	W
H1	56	15,9	15,9	8,5	165	182	49
H2	58	18	15	12	215	239	56
H3	64	24	16,5	15	265	295	71

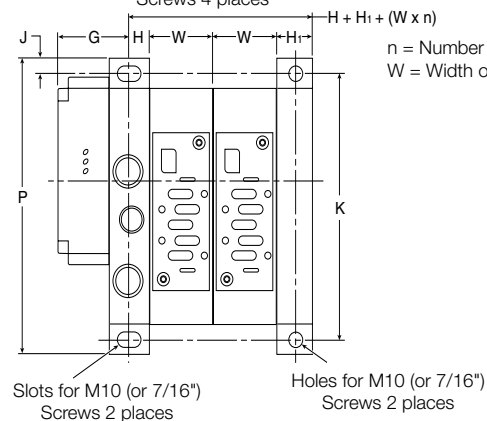

n = Number of H2 / H3 bases
 W = Width of H2 / H3 bases

Slots for M10 (or 7/16")
 Screws 2 places

Holes for M10 (or 7/16")
 Screws 2 places

Isys ISO 15407-2 & 5599-2 Sizes 02 to 3 with Moduflex Bus

HA/HB Series

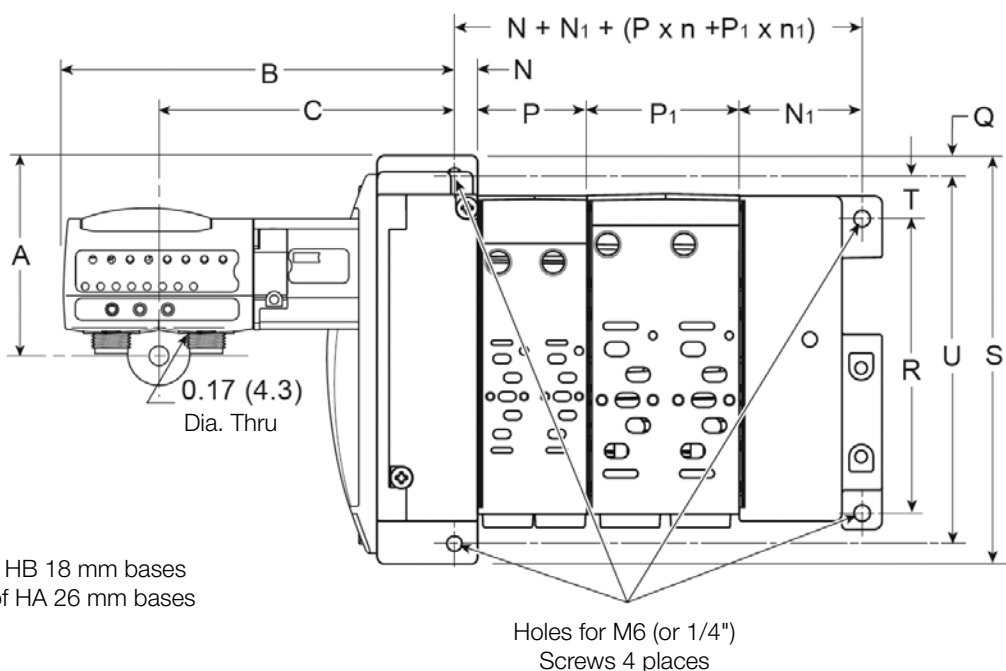

n = Number of HB 18 mm bases
 n1 = Number of HA 26 mm bases

H1/H2/H3 Series

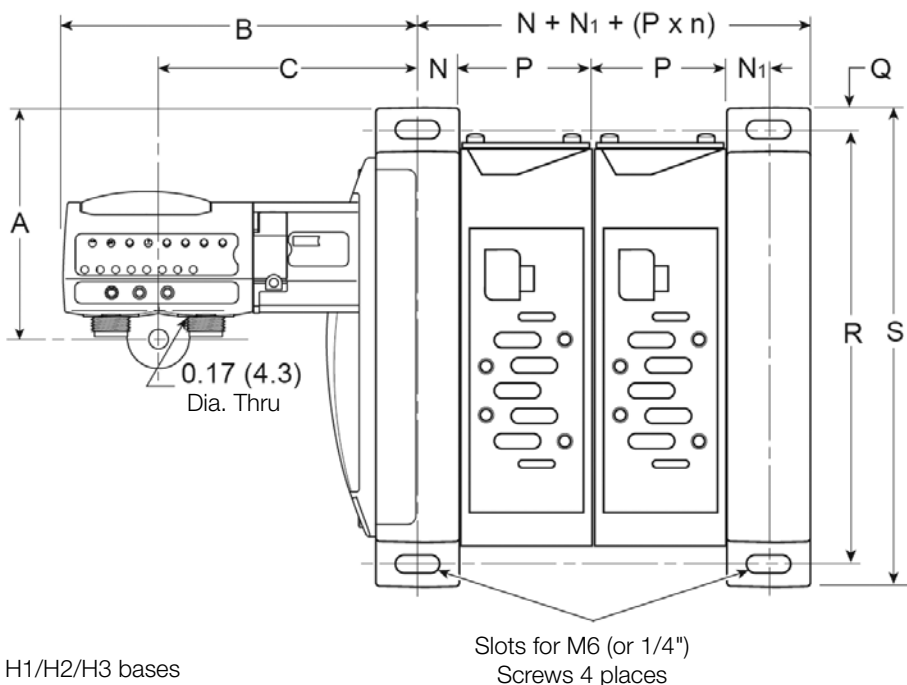

n = Number of H1/H2/H3 bases

	A	B	C	N	N ₁	P	P ₁	Q	R	S	T	U
HA/HB	69,8	142,5	111,8	8,4	45,8	40,8	56,8	4	110	152	16	137
H1	82	130,2	160,9	15,9	15,9	49	-	8,5	165	182	-	-
H2	78,2	130,3	161	18	15	56	-	12	215	239	-	-
H3	84,2	138,2	168,9	24	16,5	71	-	15	265	295	-	-

Sandwich Regulator with Gauge

HA / HB Series

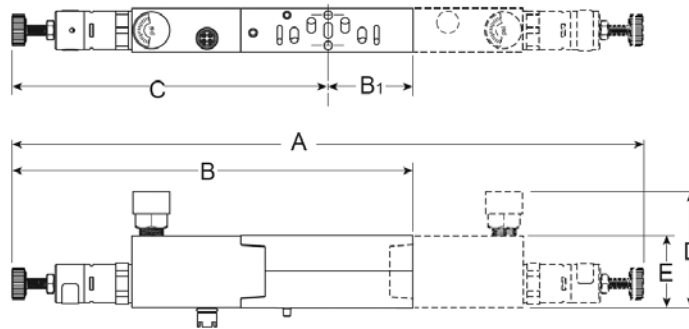

	A	B	B1	C	D	E
HB	261	156	26	130	66	30
HA	254	163	36	127	69	30

H1 Series

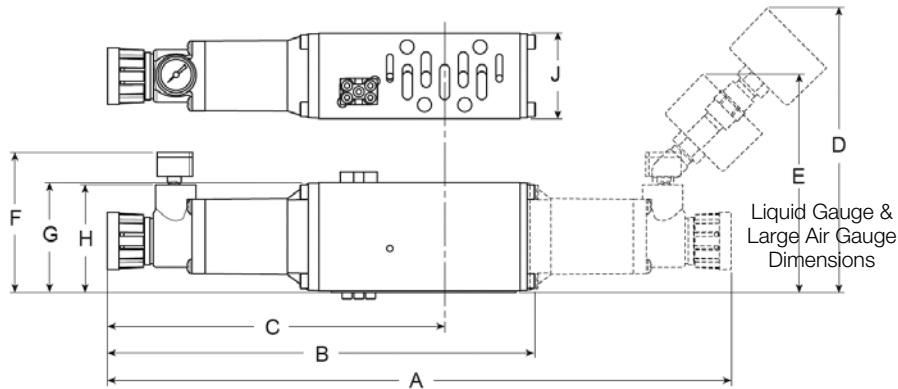

	A	B	C	D	E	F	G	H	J
H1	301	207	163	138	108	72	53	52	41

H2 / H3 Series

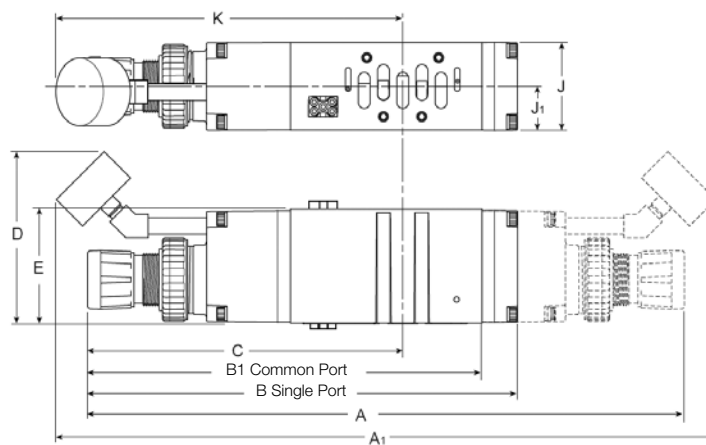

	A	A1	B	B1	C	D	E	J	J1	K
H2	372	411	268	250	196	107	71	55	27	216
H3	398	436	293	271	213	107	75	64	32	231

Sandwich Flow Control

HA Series

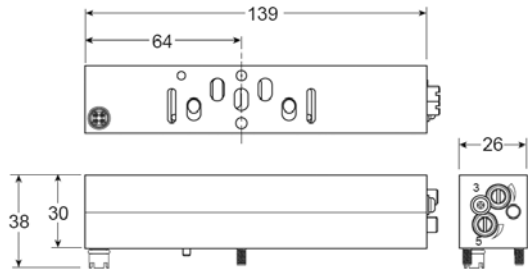

HB Series

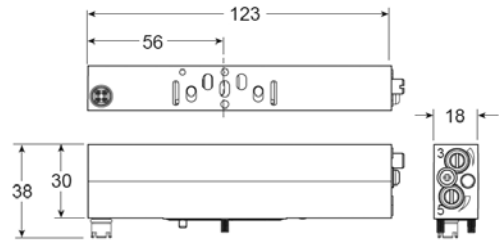

H1 Series

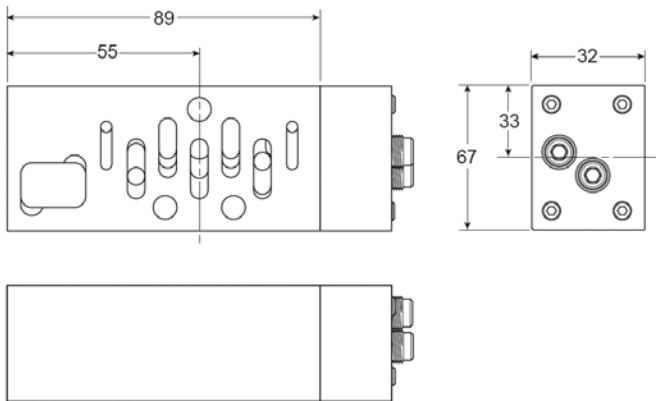

H2 Series

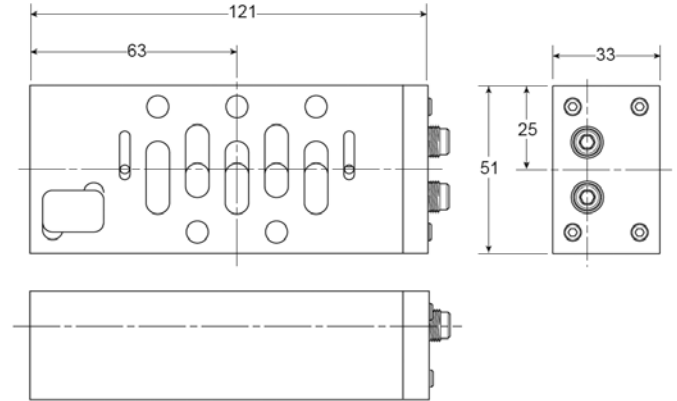

H3 Series

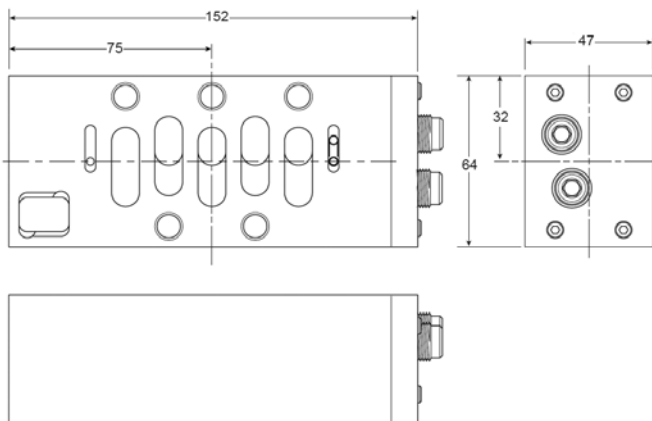

Interconnect Circuit Boards

Maximum Solenoids Energized Simultaneously

HA HB	Voltage code	25-pin D-Sub	19-pin round	Single 12-pin M23	Isysnet	
24 V DC	B9 / G9	24	16	8	32	
120 V AC*	23	24	16	8	32	
H1 H2 H3	Voltage code	25-pin D-Sub	19-pin round	Single 12-pin M23	Isysnet	SAM 3.0
12 V DC	45	13	13	8	N/A	N/A
24 V AC*	42	24	16	8	N/A	N/A
24 V DC	B9	20	16	8	21	4
120 V AC*	23	24	16	8	N/A	N/A

* Not CSA certified for 25-pin, D-Sub option.

19-Pin Round Brad Harrison

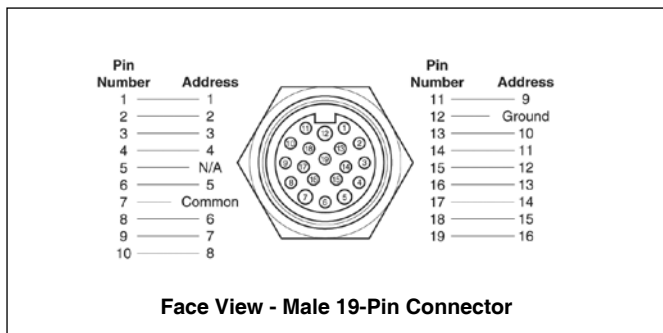

19-Pin Round Cable Specifications

Common Pin "7" is rated for 8 amps. Cable common wire must be greater than total amperage of solenoids on Add-A-Fold assembly.

Example:- 8 station manifold, 16 solenoids,
 120VAC - 16 x .039 amps = .63 total amp rating.
 NEMA 4 rated with properly assembled NEMA 4 rated cable.

Brad Harrison #333030P80M050 16.40 ft. (Female to Male Cable)

Brad Harrison #333030P80M0100 32.80 ft. (Female to Male Cable)

M23, 12-Pin Round Connector (Male)

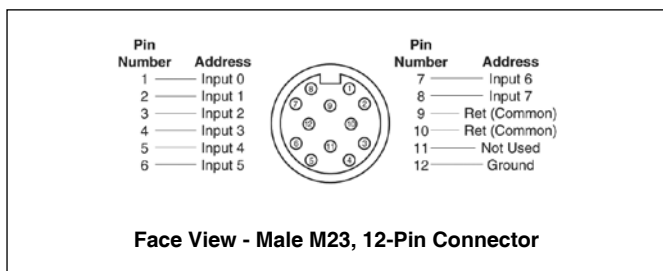

25-Pin, D-Sub Connector (Male)

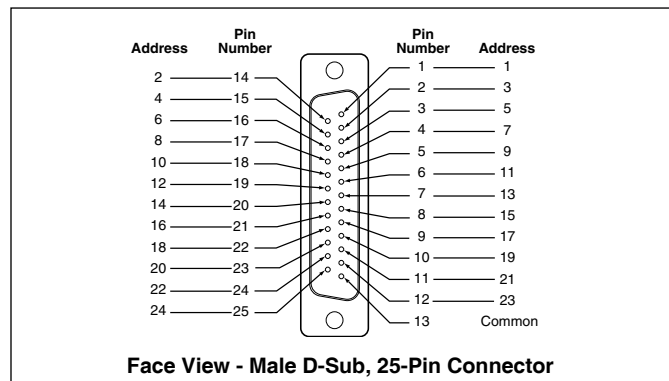

25-Pin, D-Sub Cable (Female)

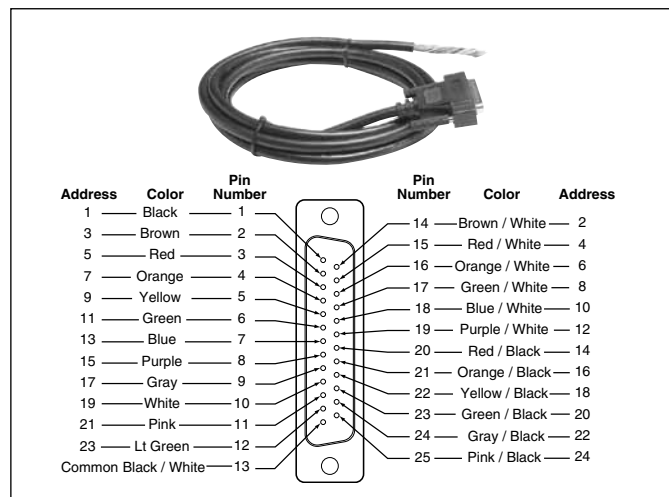

25-Pin, D-Sub Cable Specifications

Common Pin "13" is rated for 3 amps. Common wire rating must be greater than total amperage of all solenoids on a Add-A-Fold assembly.

IP65 rated with properly assembled IP65 rated cable.

M23, 12-Pin Round Connector (Female)

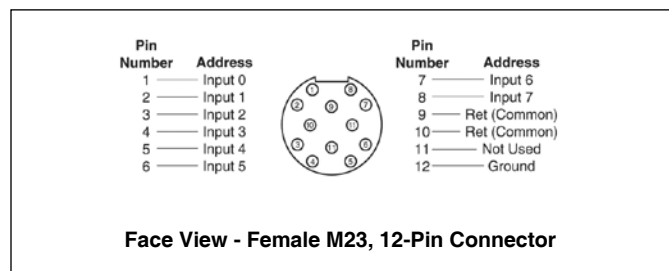

Parker Worldwide

Europe, Middle East, Africa

AE – United Arab Emirates,
Dubai

Tel: +971 4 8127100
parker.me@parker.com

AT – Austria, Wiener Neustadt

Tel: +43 (0)2622 23501-0
parker.austria@parker.com

AT – Eastern Europe, Wiener
Neustadt

Tel: +43 (0)2622 23501 900
parker.easteurope@parker.com

AZ – Azerbaijan, Baku

Tel: +994 50 2233 458
parker.azerbaijan@parker.com

BE/LU – Belgium, Nivelles

Tel: +32 (0)67 280 900
parker.belgium@parker.com

BY – Belarus, Minsk

Tel: +375 17 209 9399
parker.belarus@parker.com

CH – Switzerland, Etoy

Tel: +41 (0)21 821 87 00
parker.switzerland@parker.com

CZ – Czech Republic, Klecany

Tel: +420 284 083 111
parker.czechrepublic@parker.com

DE – Germany, Kaarst

Tel: +49 (0)2131 4016 0
parker.germany@parker.com

DK – Denmark, Ballerup

Tel: +45 43 56 04 00
parker.denmark@parker.com

ES – Spain, Madrid

Tel: +34 902 330 001
parker.spain@parker.com

FI – Finland, Vantaa

Tel: +358 (0)20 753 2500
parker.finland@parker.com

FR – France, Contamine s/Arve

Tel: +33 (0)4 50 25 80 25
parker.france@parker.com

GR – Greece, Athens

Tel: +30 210 933 6450
parker.greece@parker.com

HU – Hungary, Budapest

Tel: +36 23 885 475
parker.hungary@parker.com

IE – Ireland, Dublin

Tel: +353 (0)1 466 6370
parker.ireland@parker.com

IT – Italy, Corsico (MI)

Tel: +39 02 45 19 21
parker.italy@parker.com

KZ – Kazakhstan, Almaty

Tel: +7 7272 505 800
parker.easteurope@parker.com

NL – The Netherlands, Oldenzaal

Tel: +31 (0)541 585 000
parker.nl@parker.com

NO – Norway, Asker

Tel: +47 66 75 34 00
parker.norway@parker.com

PL – Poland, Warsaw

Tel: +48 (0)22 573 24 00
parker.poland@parker.com

PT – Portugal, Leca da Palmeira

Tel: +351 22 999 7360
parker.portugal@parker.com

RO – Romania, Bucharest

Tel: +40 21 252 1382
parker.romania@parker.com

RU – Russia, Moscow

Tel: +7 495 645-2156
parker.russia@parker.com

SE – Sweden, Spånga

Tel: +46 (0)8 59 79 50 00
parker.sweden@parker.com

SK – Slovakia, Banská Bystrica

Tel: +421 484 162 252
parker.slovakia@parker.com

SL – Slovenia, Novo Mesto

Tel: +386 7 337 6650
parker.slovenia@parker.com

TR – Turkey, Istanbul

Tel: +90 216 4997081
parker.turkey@parker.com

UA – Ukraine, Kiev

Tel +380 44 494 2731
parker.ukraine@parker.com

UK – United Kingdom, Warwick

Tel: +44 (0)1926 317 878
parker.uk@parker.com

ZA – South Africa, Kempton Park

Tel: +27 (0)11 961 0700
parker.southafrica@parker.com

North America

CA – Canada, Milton, Ontario

Tel: +1 905 693 3000

US – USA, Cleveland

Tel: +1 216 896 3000

Asia Pacific

AU – Australia, Castle Hill

Tel: +61 (0)2-9634 7777

CN – China, Shanghai

Tel: +86 21 2899 5000

HK – Hong Kong

Tel: +852 2428 8008

IN – India, Mumbai

Tel: +91 22 6513 7081-85

JP – Japan, Tokyo

Tel: +81 (0)3 6408 3901

KR – South Korea, Seoul

Tel: +82 2 559 0400

MY – Malaysia, Shah Alam

Tel: +60 3 7849 0800

NZ – New Zealand, Mt Wellington

Tel: +64 9 574 1744

SG – Singapore

Tel: +65 6887 6300

TH – Thailand, Bangkok

Tel: +662 186 7000-99

TW – Taiwan, Taipei

Tel: +886 2 2298 8987

South America

AR – Argentina, Buenos Aires

Tel: +54 3327 44 4129

BR – Brazil, Sao Jose dos Campos

Tel: +55 800 727 5374

CL – Chile, Santiago

Tel: +56 2 623 1216

MX – Mexico, Apodaca

Tel: +52 81 8156 6000

European Product Information Centre

Free phone: 00 800 27 27 5374

(from AT, BE, CH, CZ, DE, DK, EE, ES, FI,
FR, IE, IL, IS, IT, LU, MT, NL, NO, PL, PT, RU,
SE, SK, UK, ZA)

Parker Hannifin Ltd.

Tachbrook Park Drive
Tachbrook Park,
Warwick, CV34 6TU
United Kingdom
Tel.: +44 (0) 1926 317 878
Fax: +44 (0) 1926 317 855
parker.uk@parker.com
www.parker.com

